























## About This Manual

Thank you for your purchase of a Nikon D1H digital camera. This manual is designed to improve your enjoyment of this advanced single-lens reflex (SLR) digital camera. As you read through it, you will find explanations not only of how the camera works, but of how certain features can be used to take photographs in a variety of situations. The manual is divided into the following sections:

- **Getting Started** .....  pp. 1–18  
The “Getting Started” section describes the symbols and conventions used in this manual and provides a guide to the names and functions of camera controls and icons.
- **Tutorial** .....  pp. 19–50  
This section provides sufficient information to master simple “point-and-shoot” photography. After reading this section, you should know enough about your camera to enjoy the simplicity and immediacy of digital photography.
- **Reference** .....  pp. 51–154  
Like the tutorial, the reference section covers the steps involved in shooting and playback in the order most commonly followed when taking photographs, but covers these topics in greater depth. Taking playback one step further, it also describes how to view photographs on a computer or television.
- **Custom Settings and Other Menus** .....  pp. 155–191  
This section details custom settings and provides an index to camera menus.
- **Technical Notes** .....  pp. 193–223  
Refer to this section for information on optional accessories, camera care, troubleshooting, and specifications.

- For Your Safety .....  iv–v
  - Caring for the Camera and Battery .....  vi–vii
  - Notices .....  iii–xi
  - Table of Contents .....  xii–xiv
- 
- ▶ • Overview .....  pp. 2–3
  - ▶ • Getting to Know the Camera .....  pp. 4–18
- 
- ▶ • First Steps .....  pp. 20–31
  - ▶ • Taking Photographs .....  pp. 32–50
- 
- ▶ • Advanced Photography .....  pp. 52–119
  - ▶ • Playback .....  pp. 120–147
  - ▶ • Connecting Your Camera to a Computer .....  pp. 148–154
- 
- ▶ • Custom Settings .....  pp. 156–185
  - ▶ • Other Camera Menus .....  pp. 186–191
- 
- ▶ • Caring for Your Camera .....  pp. 194–197
  - ▶ • Optional Accessories .....  pp. 198–207
  - ▶ • Troubleshooting .....  pp. 208–211
  - ▶ • Specifications .....  pp. 212–219
  - ▶ • Index .....  pp. 220–223

## For Your Safety

To prevent damage to your Nikon product or injury to yourself or to others, read the following safety precautions in their entirety before using this equipment. Keep these safety instructions where all those who use the product will read them.

The consequences that could result from failure to observe the precautions listed in this section are indicated by the following symbols:



This icon marks warnings, information that should be read before using your Nikon product to prevent possible injury.

### **WARNINGS**

#### ***Do not look at the sun through the viewfinder***

Viewing the sun or other strong light source through the viewfinder could cause permanent visual impairment.

#### ***Turn off immediately in the event of malfunction***

Should you notice smoke or an unusual smell coming from the equipment or from the AC adapter (available separately), unplug the AC adapter and remove the batteries immediately, taking care to avoid burns. Continued operation could result in injury. After removing the batteries, take the equipment to a Nikon-authorized service center for inspection.

#### ***Do not use in the presence of flammable gas***

Do not use electronic equipment in the presence of flammable gas, as this could result in explosion or fire.

#### ***Do not place camera strap around neck***

Placing the camera strap around your neck could result in strangulation. Special care should be taken to avoid placing the strap around the neck of an infant or child.

#### ***Do not disassemble***

Touching the product's internal parts could result in injury. In the event of a malfunction, the product should be repaired only by a qualified technician. Should the product break open as the result of a fall or other accident, remove the battery and/or AC adapter and then take the product to a Nikon-authorized service center for inspection.

### ***Observe due precaution when handling batteries***

Batteries may leak or explode if improperly handled. Observe the following precautions when handling batteries for use in this product:

- Be sure the product is off before inserting or removing the battery. If you are using an AC adapter, be sure it is unplugged.
- Foreign substances on the battery terminals—for example, sweat or oil—may cause an interruption in current. Before installing the battery, clean it thoroughly with a soft, dry cloth.
- When the product is used on battery power for an extended period, the battery may become hot. Due caution should be observed when removing the battery.
- Use only batteries approved for use in this equipment.
- Do not expose the battery to flame or to excessive heat or moisture. Do not short-circuit or disassemble the battery.

### ***Use appropriate cables***

When connecting cables to the input and output jacks, use only the cables provided or sold by Nikon for the purpose, to maintain compliance with product regulations.

### ***Keep out of reach of children***

Particular care should be taken to prevent infants from putting batteries or other small parts into their mouths.

### ***Removing memory cards***

Memory cards may become hot during use. Observe due caution when removing memory cards from the camera.

### ***CD-ROMs***

The CD-ROMs on which the software and manuals are distributed should not be played back on audio CD equipment. Playing CD-ROMs on an audio CD player could cause hearing loss or damage the equipment.

### ***Observe caution when operating the flash***

Using a flash in close proximity to the eyes of a human or animal subject could cause permanent visual impairment. Particular care should be observed when photographing infants, when the flash should be no less than one meter (39") from the subject.

### ***Avoid contact with liquid crystal***

Should the monitor break, care should be taken to avoid injury due to broken glass and to prevent liquid crystal from the monitor touching the skin or entering the eyes or mouth.

# Caring for the Camera and Battery

## ***Do not drop***

The camera and lens may malfunction if subjected to strong shocks or vibration.

## ***Keep dry***

This product is not waterproof, and may malfunction if immersed in water or exposed to high levels of humidity. Rusting of the internal mechanism can cause irreparable damage.

## ***Avoid sudden changes in temperature***

Sudden changes in temperature, such as occur when entering or leaving a heated building on a cold day, can cause condensation inside the device. To prevent condensation, place the device in its carrying case or a plastic bag before exposing it to sudden changes in temperature.

## ***Keep away from strong magnetic fields***

Do not use or store this device in the vicinity of equipment that generates strong electromagnetic radiation or magnetic fields. Strong static charges or the magnetic fields produced by equipment such as radio transmitters could interfere with the monitor; damage data stored on the memory card, or affect the product's internal circuitry.

## ***Do not touch the shutter curtain***

The shutter curtain is constructed of extremely thin material that is easily damaged. Under no circumstances should you exert pressure on the curtain, poke it with cleaning tools or other implements, or subject it to powerful air currents from a blower. These actions could scratch, deform, or tear the curtain.

## ***Cleaning***

- When cleaning the camera body, use a blower to remove dust and lint, then wipe gently with a soft, dry cloth. After using your camera at the beach or seaside, wipe off any sand or salt using a cloth lightly dampened with pure water and then dry your camera thoroughly. In rare instances, static electricity produced by a brush or cloth may cause the LCD displays to light up or darken. This does not indicate a malfunction, and the display will shortly return to normal.
- When cleaning the lens and mirror, remember that these elements are easily damaged. Dust and lint should be gently removed with a blower. When using an aerosol blower, keep the can vertical (tilting the can could result in liquid being sprayed on the mirror). If you do get a fingerprint or other stain on the lens, apply a small amount of lens cleaner to a soft cloth and wipe the lens carefully.
- See "Technical Notes: Caring for Your Camera" for information on cleaning the low-pass filter.

## ***Storage***

- To prevent mold or mildew, store the camera in a dry, well-ventilated area. If you will not be using the product for a long period of time, remove the battery to prevent leakage and store the camera in a plastic bag containing a desiccant. Do not, however, store the camera case in a plastic bag, as this may cause the material to deteriorate. Note that desiccant gradually loses its capacity to absorb moisture and should be replaced at regular intervals.

- Do not store the camera with naphtha or camphor moth balls, close to equipment that produces strong magnetic fields, or in areas subject to extremes of temperature, for example near a space heater or in a closed vehicle on a hot day.
- To prevent mold or mildew, take the camera out of storage at least once a month. Turn the camera on and release the shutter a few times before putting the camera away again.
- Store the battery in a cool, dry place.
- Before storing EN-4 battery packs that have been removed from the camera, replace the cover that protects the terminals used for connection to a recharger.

### **Notes on the Monitor**

- The monitor may contain a few pixels that are always lit or that do not light. This is a characteristic common to all TFT LCD monitors and does not indicate a malfunction. Images recorded with the camera will not be affected.
- Images in the monitor may be difficult to see in a bright light.
- Do not apply pressure to the monitor; as this could cause damage or malfunction. Dust or lint adhering to the monitor can be removed with a blower brush. Stains can be removed by rubbing the surface lightly with a soft cloth or chamois leather.
- Should the monitor break, care should be taken to avoid injury due to broken glass and to prevent the liquid crystal from the monitor touching the skin or entering the eyes or mouth.
- Replace the monitor cover when transporting the camera or leaving it unattended.

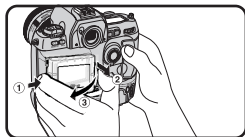
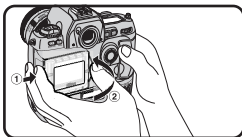

- Do not touch the battery terminals with other metal objects. Keep the battery terminals clean.

### **Turn the product off before removing the battery or unplugging the AC adapter**

Do not unplug the product or remove the battery while the camera is on, or while images are being recorded or deleted from memory. Forcibly cutting power to the product in these circumstances could result in loss of data or in damage to the internal circuitry or memory. To prevent an accidental interruption of power, avoid carrying the product from one location to another while the AC adapter is connected.

### **Keep a fully-charged spare battery on hand**

Ready a spare battery and keep it fully charged when taking photographs on important occasions. Depending on your location, you may find it difficult to purchase replacement batteries on short notice.

On cold days, the capacity of batteries tends to decrease. Be sure the battery is fully charged before taking photographs outside in cold weather. Keep a spare battery in a warm place and exchange the two as necessary. Once warmed, a cold battery may recover some of its charge.

- No part of the manuals included with this product may be reproduced, transmitted, transcribed, stored in a retrieval system, or translated into any language in any form, by any means, without Nikon's prior written permission.
- Nikon reserves the right to change the specifications of the hardware and software described in these manuals at any time and without prior notice.
- Nikon will not be held liable for any damages resulting from the use of this product.
- While every effort has been made to ensure that the information in these manuals is accurate and complete, we would appreciate it were you to bring any errors or omissions to the attention of the Nikon representative in your area (address provided separately).

### **Notice for customers in Canada**

#### CAUTION

This class B digital apparatus meets all requirements of the Canadian Interference Causing Equipment Regulations.

#### ATTENTION

Cet appareil numérique de la classe B respecte toutes les exigences du Règlement sur le matériel brouilleur du Canada.

## **Notice for customers in the U.S.A.**

### *Federal Communications Commission (FCC) Radio Frequency Interference Statement*

This equipment has been tested and found to comply with the limits for a Class B digital device, pursuant to Part 15 of the FCC rules. These limits are designed to provide reasonable protection

against harmful interference in a residential installation. This equipment generates, uses, and can radiate radio frequency energy and, if not installed and used in accordance with the instructions, may cause harmful interference to radio communications. However, there is no guarantee that interference will not occur in a particular installation. If this equipment does cause harmful interference to radio or television reception, which can be determined by turning the equipment off and on, the user is encouraged to try to correct the interference by one or more of the following measures:

- Reorient or relocate the receiving antenna.
- Increase the separation between the equipment and receiver.
- Connect the equipment into an outlet on a circuit different from that to which the receiver is connected.
- Consult the dealer or an experienced radio/television technician for help.

### CAUTIONS

#### ***Modifications***

The FCC requires the user to be notified that any changes or modifications made to this device that are not expressly approved by Nikon Corporation may void the user's authority to operate the equipment.

#### ***Interface Cables***

Use the interface cables sold or provided by Nikon for your equipment. Using other interface cables may exceed the limits of Class B Part 15 of the FCC rules.

Nikon Inc.,  
1300 Walt Whitman Road, Melville, New York  
11747-3064, U.S.A.  
Tel.: 631-547-4200

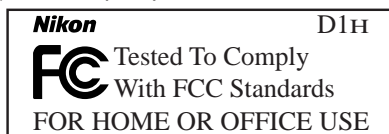



### **Notice Concerning Prohibition of Copying or Reproduction**

Note that simply being in possession of material that has been digitally copied or reproduced by means of a scanner, digital camera or other device is punishable by law.

- **Items prohibited by law from being copied or reproduced**

Do not copy or reproduce paper money, coins, securities, government bonds, or local government bonds, even if such copies or reproductions are stamped "Sample."

The copying or reproduction of paper money, coins, or securities which are circulated in a foreign country is prohibited.

Unless the prior permission of the government has been obtained, the copying or reproduction of unused postage stamps or post cards issued by the government is prohibited.

The copying or reproduction of stamps issued by the government and of certified documents stipulated by law is prohibited.

- **Cautions on certain copies and reproductions**

The government has issued cautions on copies or reproductions of securities issued by private companies (shares, bills, checks, gift certificates, etc.), commuter passes, or coupon tickets, except when a minimum of necessary copies are to be provided for business use by a company. Also, do not copy or reproduce passports issued by the government, licenses issued by public agencies and private groups, ID cards, and tickets, such as passes and meal coupons.

- **Comply with copyright notices**

The copying or reproduction of copyrighted creative works such as books, music, paintings, woodcut prints, maps, drawings, movies, and photographs is prohibited except when it is done for personal use at home or for similar restricted and non-commercial use.

## **Trademark Information**

Apple, the Apple logo, Macintosh, Mac OS, Power Macintosh, and PowerBook are registered trademarks of Apple Computer, Inc. Finder and Power Mac are trademarks of Apple Computer, Inc. IBM and IBM PC/AT are registered trademarks of International Business Machines Corporation. microdrive is a trademark of International Business Machines Corporation. PowerPC is a trademark of International Business Machines Corporation, used under license. Microsoft is a registered trademark, and Windows, MS-Windows and Windows NT trademarks, of Microsoft Corporation. CompactFlash is a trademark of SanDisk corporation. All other trade names mentioned in this manual or the other documentation provided with your Nikon product are trademarks or registered trademarks of their respective holders.

# Table of Contents

About This Manual .....	ii
For Your Safety .....	iv
Caring for the Camera and Battery .....	vi
Notices .....	viii
<b>Getting Started .....</b>	<b>1</b>
Overview .....	2
Getting to Know the Camera .....	4
<b>Tutorial .....</b>	<b>19</b>
First Steps .....	20
Step 1: Inserting a Battery .....	22
Step 2: Attaching a Lens .....	24
Step 3: Inserting a Memory Card .....	26
Step 4: Choosing a Language .....	28
Step 5: Setting the Time and Date .....	30
Taking Photographs .....	32
Step 0: Before You Begin .....	34
Step 1: Adjusting Camera Settings .....	36
Step 2: Framing a Photograph .....	43
Step 3: Focusing .....	44
Step 4: Checking Exposure .....	46
Step 5: Shooting .....	47
Step 6: Checking the Results .....	48
<b>Reference .....</b>	<b>51</b>
Advanced Photography .....	52
Shooting Modes .....	52
Image Quality .....	56
Sensitivity (ISO Equivalency) .....	62
White Balance .....	64
Autofocus .....	70

Focus Area Selection .....	73
AF-Area Mode .....	74
Focus Lock .....	78
Getting Good Results with Autofocus .....	80
Manual Focus .....	81
Metering .....	82
Exposure Mode .....	84
Auto-Exposure Lock .....	96
Exposure Compensation .....	98
Auto Bracketing .....	100
Self-Timer Mode .....	103
Diopter Adjustment .....	104
LCD Illuminators .....	105
Depth-of-Field Preview .....	106
Focal Plane Position .....	107
Through-the-Lens Flash Photography .....	108
Flash Contacts and Indicators .....	109
Flash Sync Modes .....	110
Compatible Speedlights .....	112
The FUNC Button .....	116
Sequential File Numbering .....	117
Taking Photographs with GPS .....	118
<b>Playback .....</b>	<b>120</b>
Playback Options .....	120
Basic Playback .....	122
Playback Menu Options .....	134
Setup Menu Options .....	143
Television Playback .....	146
<b>Connecting to a Computer .....</b>	<b>148</b>
Software for the D1H .....	150
Reading Photographs from Memory Cards .....	154

## Table of Contents *(continued)*

<b>Custom Settings and Other Menus .....</b>	<b>155</b>
Custom Settings .....	156
Other Camera Menus .....	186
<b>Technical Notes .....</b>	<b>193</b>
Caring for Your Camera .....	194
Optional Accessories .....	198
Troubleshooting .....	208
Specifications .....	212
Index .....	220

# GETTING STARTED

- **Overview ..... pp. 2–3**
- **Getting to Know the Camera  
..... pp. 4–18**

---

## About This Section

---

This section describes the symbols and conventions used in this manual and provides a guide to the names and functions of camera controls and icons.

---

This manual is designed to help you enjoy taking digital photographs with an advanced single-lens reflex (SLR) digital camera. The D1H offers:

- A 2.74-million pixel, 23.7 mm × 15.6 mm (0.93" × 0.61") image-sensing charged-coupled device (CCD) capable of capturing images of 2,000 × 1,312 pixels in size
- Newly designed 3D digital matrix image control with 3D color matrix metering, through-the-lens (TTL) white balance, and tone compensation for precise exposure control, adaptive auto white-balance control, and optimal color accuracy
- A choice of two color modes (one optimized for the sRGB color space, the other for the Adobe RGB color space), giving users the power to select a color space suited according to their production work-flow
- An enhanced shooting speed of approximately five frames per second for up to forty consecutive shots (twenty-seven shots in RAW mode)
- A menu of 0–35 custom settings displayed on the camera monitor in your choice of English, French, German, or Japanese
- Lossless compression of RAW image data to increase the number of images that can be stored on a single memory card and to enhance transfer speed, all without sacrificing image quality



## Service Your Camera and Accessories

Your camera is a precision machine and requires regular servicing. We recommend that you have your camera inspected by your retailer or Nikon service representative once every one to two years, and that you have it serviced once every three to five years (note that fees are charged for these services). Frequent inspection and servicing are particularly recommended if you use your camera professionally. When having your camera inspected or serviced, we recommend that you bring you bring any accessories regularly used with the camera, such as lenses and flash units.



## Buying Camera Accessories

Your camera is optimized for use with Nikon-brand accessories. Accessories sold by other manufacturers may not be made to Nikon specifications and could damage your camera. Nikon can not guarantee performance when the camera is used with non-Nikon accessories.



## Replacing This Manual

Should you lose this manual, replacements can be ordered, for a fee, from any authorized Nikon service representative.

To make it easier to find the information you need, the following symbols and conventions are used:



This icon marks cautions, information that you should read before using your camera to prevent damage to the device.



This icon marks notes, information that you should read before using your camera.



This icon marks tips, additional information you may find helpful when using your camera.



This icon indicates that more information is available elsewhere in this manual.



This symbol marks settings that can be adjusted using the camera menus.



This symbol marks camera settings that can be fine-tuned using the custom setting or settings indicated by the number following the symbol.



## Take Test Photos

Before taking photographs on important occasions (for example, at weddings or before taking the camera on a trip), take a test shot to ensure that the camera is functioning normally. Nikon will not be held liable for costs or lost profits that may result from product malfunction.



## Life-Long Learning

As part of Nikon's "Life-Long Learning" commitment to ongoing product support and education, continually-updated information is available on-line at the following sites:

- For users in the U.S.A.: <http://www.nikonusa.com/>
  - For users in Europe: <http://www.nikon-euro.com/>
  - For users in Asia, Oceania, the Middle East, and Africa: <http://www.nikon-asia.com/>
- Visit these sites to keep up-to-date with the latest product information and general advice on digital imaging and photography.

For more information, please contact your nearest Nikon representative.

<http://www.kt.co.jp/Nikon/Network/index.html>



# Getting to Know the Camera

Take a few moments to familiarize yourself with camera controls.

## Camera Body

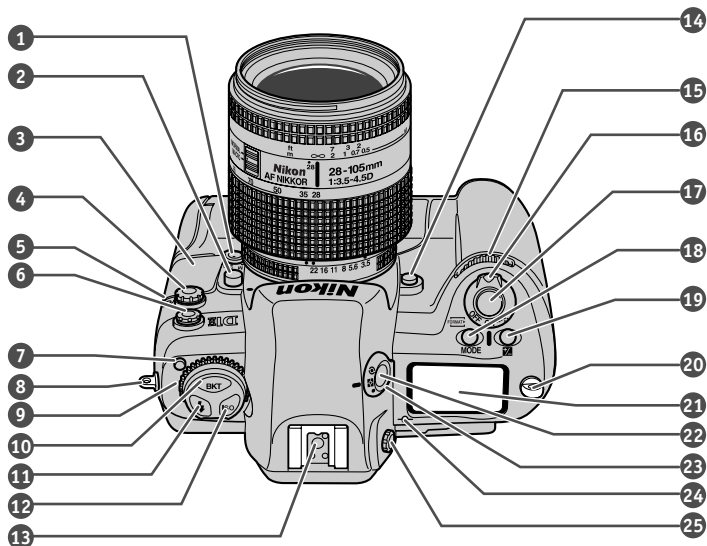

- 1 Focus-mode selector dial ..... pg. 70
- 2 Lens release button ..... pg. 25
- 3 DC in, video out connector cover  
..... pg. 146
- 4 10-pin remote terminal ..... pg. 206
- 5 Self-timer lamp ..... pg. 103
- 6 Sync terminal for external flash ... pg. 109
- 7 Mode dial lock release ..... pg. 13
- 8 Eyelet for camera strap ..... pg. 12
- 9 Mode dial ..... pg. 13
- 10 Auto-bracketing button ..... pg. 100, 217
- 11 Flash sync mode button ..... pg. 110
- 12 Sensitivity button ..... pg. 62
- 13 Accessory shoe ..... pg. 109
- 14 Depth-of-field preview button ... pg. 106
- 15 Sub-command dial ..... pg. 14
- 16 Power switch ..... pg. 23
- 17 Shutter-release button ..... pp. 44–47, 78
- 18 Exposure mode button ..... pp. 84–93  
Format button ..... pg. 27
- 19 Exposure compensation button  
..... pg. 98, 217
- 20 Eyelet for camera strap ..... pg. 12
- 21 Top control panel ..... pg. 8
- 22 Metering selector lock button ..... pg. 82
- 23 Metering selector ..... pg. 82
- 24 Focal plane indicator ..... pg. 107
- 25 Diopter adjustment knob ..... pg. 104

## Camera Body (continued)

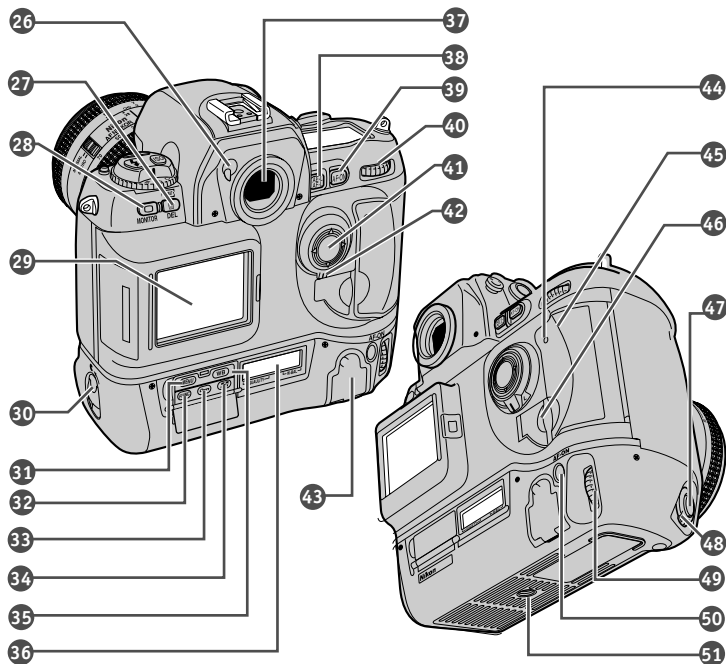

- 26 Eyepiece shutter lever ..... pg. 103
- 27 Delete/Format button ..... pg. 27, 129
- 28 Monitor button ..... pg. 120, 123
- 29 LCD monitor ..... pg. vii, 17, 120
- 30 Battery pack latch ..... pg. 22
- 31 MENU button ..... pg. 17
- 32 FUNC button ..... pg. 18, 116
- 33 Protect button ..... pg. 132
- 34 Thumbnail button ..... pg. 122
- 35 White-balance button ..... pg. 64
- 36 Rear control panel ..... pg. 8
- 37 Viewfinder eyepiece
- 38 AE/AF lock button ..... pg. 78, 96
- 39 AF start (AF-ON) button ..... pg. 72
- 40 Main command dial ..... pg. 14
- 41 Multi selector ..... pg. 16, 73, 124
- 42 Multi selector lock ..... pg. 73
- 43 Interface connector cover ... pg. 119, 148
- 44 Memory card access lamp ..... pg. 47
- 45 Cover for CompactFlash card slot.. pg. 26
- 46 Card slot cover release button  
(under cover) ..... pg. 26
- 47 Shutter-release button  
(vertical shooting) ..... pg. 43
- 48 Shutter-release button lock  
(vertical shooting) ..... pg. 43
- 49 Main command dial  
(vertical shooting) ..... pg. 14
- 50 AF start (AF-ON) button  
(vertical shooting) ..... pg. 72
- 51 Tripod socket

## The Top Control Panel

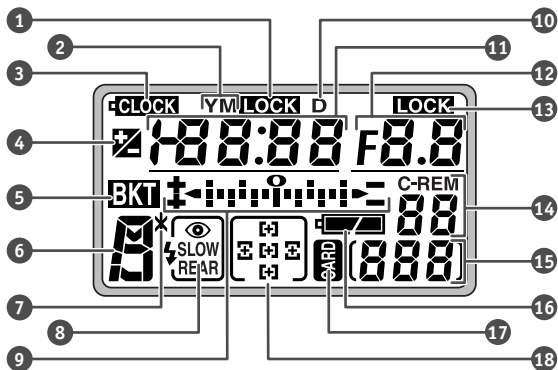

## The Rear Control Panel

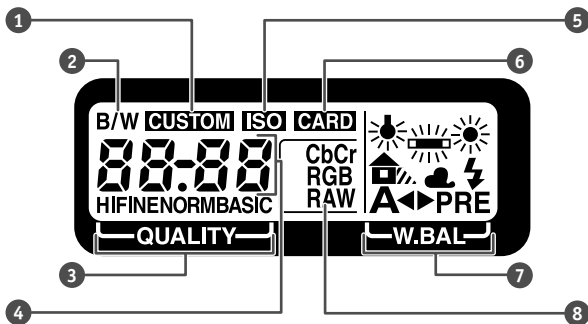

- |  |  |
|--|--|
| <ul style="list-style-type: none"> <li>1 Shutter-speed lock indicator ..... pg. 94</li> <li>2 Year/month indicator ..... pg. 217</li> <li>3 Clock battery indicator ..... pg. 31</li> <li>4 Exposure compensation indicator .. pg. 98</li> <li>5 Bracketing indicator ..... pg. 100</li> <li>6 Exposure mode ..... pp. 84–93</li> <li>7 Flexible program indicator ..... pg. 85</li> <li>8 Flash sync mode ..... pg. 110</li> <li>9 Electronic analog exposure display ..pg. 92<br/>Exposure compensation ..... pg. 98</li> <li>10 Day indicator ..... pg. 217<br/>GPS signal indicator ..... pg. 118</li> </ul> | <ul style="list-style-type: none"> <li>11 Shutter speed ..... pg. 86, 91<br/>Exposure compensation ..... pg. 98<br/>Date and time ..... pg. 217</li> <li>12 Aperture display ..... pg. 88, 91<br/>Playback indicator ..... pg. 120</li> <li>13 Aperture lock indicator ..... pg. 94</li> <li>14 Number of exposures remaining ... pg. 34<br/>PC mode indicator ..... pg. 149</li> <li>15 Current frame number ..... pg. 27</li> <li>16 Battery indicator ..... pg. 23</li> <li>17 CompactFlash Memory card indicator<br/>..... pg. 27</li> <li>18 Focus area ..... pg. 73</li> </ul> |
| <ul style="list-style-type: none"> <li>1 Custom-settings indicator ..... pg. 159</li> <li>2 Black-and-white mode ..... pg. 59</li> <li>3 Image quality display ..... pg. 59</li> <li>4 Sensitivity ..... pg. 62<br/>Number of exposures remaining ... pg. 34<br/>File type ..... pg. 59<br/>Custom settings number ..... pg. 159</li> </ul>  | <ul style="list-style-type: none"> <li>5 Sensitivity indicator ..... pg. 62</li> <li>6 Memory card indicator ..... pg. 34</li> <li>7 White-balance mode ..... pg. 64</li> <li>8 Image quality (image format) ..... pg. 60</li> </ul>   |

## The Viewfinder Display

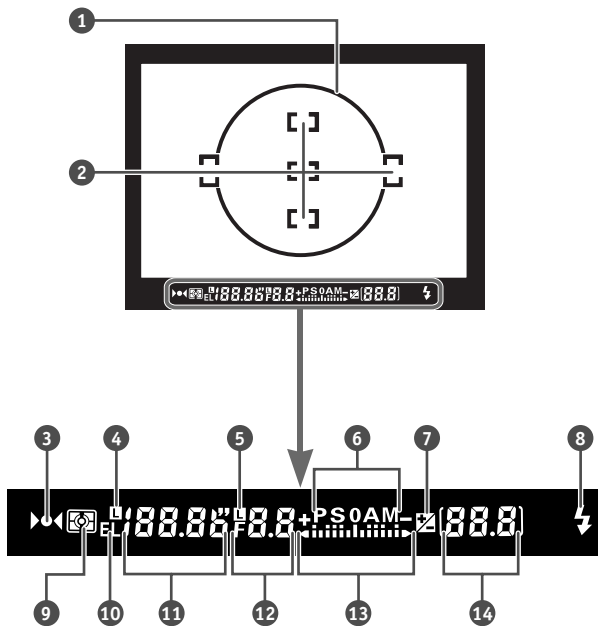

- |    |   |            |
|----|---|------------|
| 1  | 12-mm (0.47") reference circle for center-weighted metering ..... | pg. 83     |
| 2  | Focus brackets (focus areas) .....                                | pg. 73     |
|    | Spot-metering targets .....                                       | pg. 83     |
| 3  | Focus indicator .....   | pg. 45     |
| 4  | Shutter-speed lock .....  | pg. 94     |
| 5  | Aperture lock .....   | pg. 94     |
| 6  | Exposure mode .....   | pp. 84–93  |
| 7  | Exposure compensation indicator ..                                | pg. 98     |
| 8  | Flash-ready indicator .....                                       | pg. 109    |
| 9  | Metering system .....   | pg. 83     |
|    | Battery indicator .....   | pg. 23     |
| 10 | Auto-exposure lock .....  | pg. 96     |
| 11 | Shutter speed .....   | pg. 86, 91 |
| 12 | Aperture .....  | pg. 88, 91 |
| 13 | Electronic analog exposure display ..                             | pg. 92     |
|    | Exposure compensation .....                                       | pg. 98     |
| 14 | Frame counter .....   | pg. 34     |
|    | Exposures remaining in buffer .....                               | pg. 53     |
|    | Exposure compensation value .....                                 | pg. 98     |



# Getting to Know the Camera (continued)

## Accessories

The following items are included with your camera:



BF-1A body cap



Monitor cover

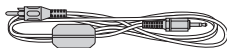

EG-D1 video cable

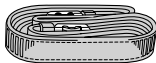

AN-D1H camera strap\*



D1H User's Manual  
(this manual)



Nikon View 4  
CD



Reference CD  
(contains Nikon View 4  
Reference Manual)

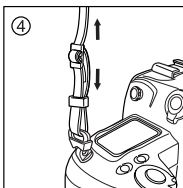
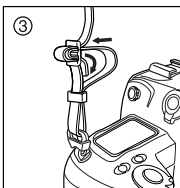
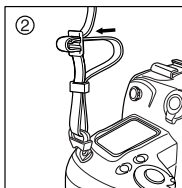
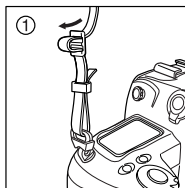

Image database  
software CD

\* The camera strap contains leather, which may fade if abraded or left in contact with a damp object for an extended period.

## Attaching the Camera Strap



Attach the strap securely to the two eyelets on the camera body as shown below.

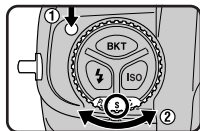

## The Mode Dial

To select the operating mode, press the mode-dial lock button and turn the mode dial to the desired setting.



Mode	Description	
 Self-timer	Use this mode to reduce blurring caused by camera shake or to appear in photographs you take yourself.	pg. 103
<b>S</b> Single-frame	The camera takes one photograph each time the shutter-release button is pressed.	pg. 52
<b>C</b> Continuous	Photographs are taken one after the other while the shutter-release button is held down.	pg. 52
<b>PLAY</b> Playback	This mode is used when viewing and deleting photographs stored on the camera's memory card.	pg. 120
<b>PC</b> PC mode	This mode is used when the camera is connected to a computer.	pg. 148







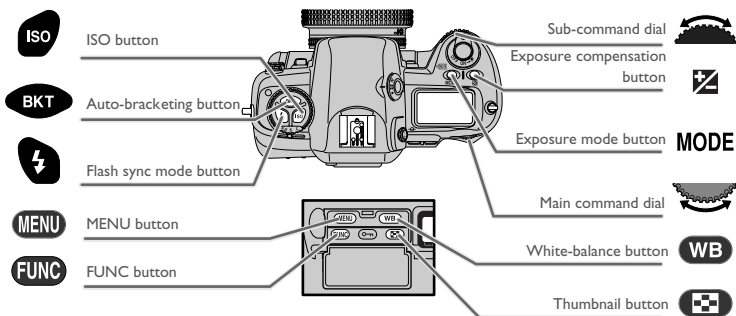





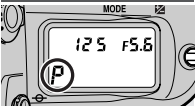

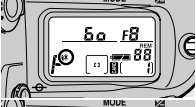

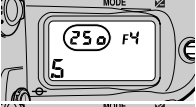

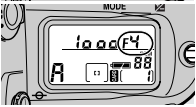
# Getting to Know the Camera (continued)

## Buttons and Command Dials

The main- and sub-command dials are used in combination with the buttons on the top and rear of the camera to adjust a variety of settings. For ease of access when taking photographs in tall (portrait) orientation, a dial that duplicates the functions of the main command dial has been placed close to the shutter-release button for portrait-orientation photographs.

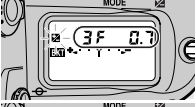

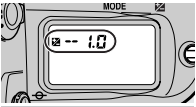

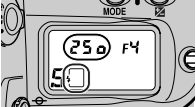

	To	press	rotate	and view	
WHITE BALANCE	Choose a white-balance setting	<b>WB</b>			pg. 64
	Fine-tune white balance/ select a preset value for white balance	<b>WB</b>			pg. 66
SENSITIVITY	Set sensitivity (ISO equivalency)	<b>ISO</b>			pg. 62

	To	press	rotate	and view	
<b>EXPOSURE</b>	Choose the exposure mode	<b>MODE</b>			pp. 84–93
	Choose a combination of aperture and shutter speed (programmed auto exposure mode)	—			pg. 85
	Choose a shutter speed (shutter-priority auto or manual exposure mode)	—			pg. 86, pg. 90
	Choose an aperture (aperture-priority auto or manual exposure mode)	—			pg. 88, pg. 90
	Set or cancel auto bracketing				pg. 100
	Choose the number of exposures and exposure compensation for auto bracketing				pg. 100
	Choose a value for exposure compensation				pg. 98
<b>FLASH</b>	Set the flash sync mode (when using optional Nikon Speedlight)				pg. 110

## Using the Multi Selector

Press the multi selector up, down, left, or right to perform the following operations.

Press	Operation
	<b>Highlight menu items</b> To highlight menu items or options, press the multi selector up or down.
	<b>Select menu items</b> Press the multi selector to the right to select the highlighted menu item or option (note that some menus do not allow you to make a selection by pressing the multi selector to the right). Selecting a menu item will sometimes display a new sub-menu of options.
	<b>Return to the previous menu without making selection</b> To return to the previous menu without making a selection, press the multi selector to the left (note that you can not exit from some menus by pressing the multi selector to the left).
	<b>Choose the focus area</b> To select any of the five focus areas, press the multi selector up, down, left, or right. <b>Highlight thumbnails</b> To highlight a thumbnail in the thumbnail display or in a thumbnail menu, press the multi selector up, down, left, or right.

## Using the Camera Menus

Changes to a variety of settings can be made with the help of menus that appear in the camera monitor. Four menus are available, each of which controls a different aspect of camera operation.

Menu	Function	
PLAYBACK	Advanced playback operations, such as automated playback (“slide shows”), deleting multiple images, and choosing the folder for playback.	pp. 186-187
SHOOTING	Advanced shooting options, such as image quality and AF-area mode. Many of these functions can also be accessed using the buttons and command dials. This menu is not available in playback mode.	pp. 188-189
CUSTOM	Fine details of camera operation. This menu is not available in playback mode.	pp. 155-185
SETUP	Basic camera setup (e.g., formatting memory cards, setting the time and date).	pp. 190-191

### Viewing the Menus

When the camera is on, the menus can be displayed by pressing the **MENU** button.

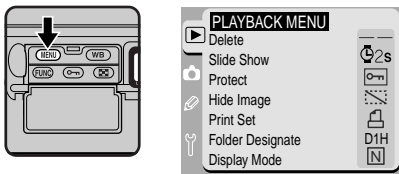

Press the **MENU** button a second time to exit the menu. If any images have been recorded to the memory card, the most recent image will be displayed. In single-frame, continuous, self-timer, and PC modes, pressing the shutter-release button halfway clears the menu from the screen and focuses the camera, readying it for the next shot.

### Exiting from the Menu

In single-frame, continuous, self-timer and PC modes, pressing the shutter-release button halfway clears the menu from the screen and focuses the camera, readying it for the next shot. The menu can be cleared from the screen in all modes by pressing the **OK** button or turning the camera off and then on again. When the camera is in playback mode, the menu can also be cleared from the screen by selecting another mode.

## Getting to Know the Camera (continued)

### Choosing a Menu

When the mode dial is set to PLAY, pressing the **MENU** button displays the playback menu. In single-frame, continuous, self-timer, and PC modes, the shooting menu will be displayed. Unlock the multi selector and press the multi selector up or down to display additional menus. Press the multi selector to the right to enter the selected menu.

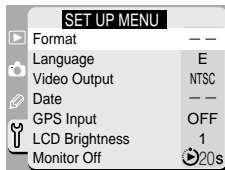
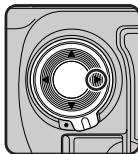
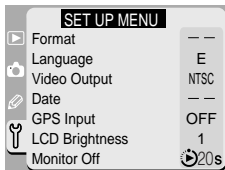
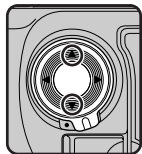

If you have already highlighted an item in the menu, press the multi selector to the left so that no item is highlighted, and then select another menu as described above.

### Making a Selection

Press the multi selector up or down to highlight a menu item, then press the selector to the right. If more options are available for the selected item, a sub-menu will be displayed; press the multi selector up or down to highlight the desired option, then press the selector to the right or press the **FUNC** button to put your choice into effect and return to the main menu.

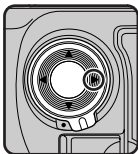
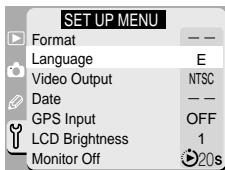
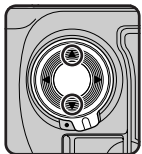

Changes to settings take effect as soon as a selection is made. To go back one step without making a selection, press the multi selector to the left.



### The Playback Menu

The playback menu can only be displayed when a memory card is inserted in the camera.



Some menu items may not be available while images are being recorded to the memory card. If the selector can not be pressed to the right then please use the **FUNC** button to put your choice into effect and return to the main menu.

## TUTORIAL

- *First Steps* .....pp. 20–31
- *Taking Photographs*  
..... pp.32–50

---

### About This Section

---











In this section, you will learn how to set up your camera for use and master the basics of simple “point-and-shoot” photography.

---









Before using your camera for the first time, you will need complete the steps shown below. More information on the topics covered in this section may be found in the chapters “Custom Settings and Other Menus” and “Technical Notes.”

## TUTORIAL: FIRST STEPS

- |        |                                 |   |           |   |
|--------|---------------------------------|---|-----------|---|
| STEP 1 | Inserting a Battery .....       |  | pp. 22–23 |  |
| STEP 2 | Attaching a Lens .....          |  | pp. 24–25 |  |
| STEP 3 | Inserting a Memory Card .....   |  | pp. 26–27 |  |
| STEP 4 | Choosing a Language .....       |  | pp. 28–29 |  |
| STEP 5 | Setting the Time and Date ..... |  | pp. 30–31 |  |

**SEE ALSO**

- ▶ • Caring for the Camera and Battery .....  vi–vii
- ▶ • Technical Notes: Optional Accessories .....  pp. 198–207
- ▶ • Technical Notes: Optional Accessories .....  pp. 198–207
- ▶ • Technical Notes: Optional Accessories .....  pp. 198–207
- ▶ • Custom Settings and Other Menus .....  pp. 155–191
- ▶ • Technical Notes: Specifications .....  pp. 212–219

## 1—Inserting a Battery

In this step, you will insert a battery and check the battery level. Your camera uses a rechargeable nickel-metal hydride (NiMH) power source, the EN-4 battery pack, which is available from Nikon for separate purchase. Contact a Nikon-authorized retailer or representative for information on purchasing EN-4 battery packs.

### 1.1 Charge the battery pack

Charge the EN-4 before use for the first time. To maximize shooting time, battery packs should be fully charged before use. The EN-4 can be charged in about ninety minutes using the MH-16 Quick Charger (available separately).

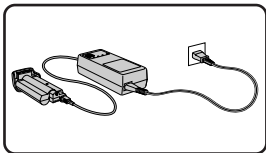

### 1.2 Insert the battery pack

Turn the camera off before inserting or removing the battery pack (A). Open the battery pack latch (B) and insert the battery pack into the camera (C).

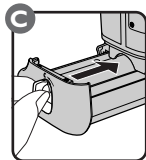
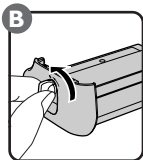
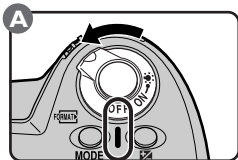

### 1.3 Latch the battery pack

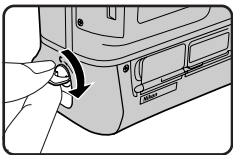

## Battery Chargers for the EN-4

In addition to the MH-16, the EN-4 can be recharged using the MH-17 Quick Charger (which plugs into vehicle cigarette lighters), the MH-15 Quick Charger for F100 film cameras, and the EH-3 Quick Charger for E3/E3s digital cameras.





## For more information on:

pg. 202 Optional accessories

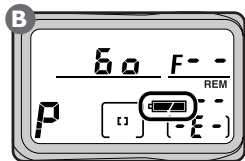
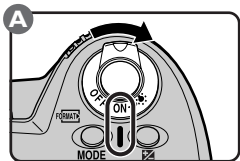

## 1.4 Check the amount of charge remaining

Turn the camera on (A) and confirm the battery level in the control panel on top of the camera (B).



 Battery fully charged

 Low battery

Ready a fully-charged spare battery pack (the metering indicator [  ,  ,  ] in the viewfinder will blink to warn that the battery is low, and the display in the viewfinder will turn off to save power when no operations are performed)

 Battery exhausted

No photographs can be taken until the battery has been replaced



### Removing Battery Packs

To remove the battery pack from the camera, unlatch the battery pack and slide it out. Do not remove the battery without first turning the power off.



### Auto Power Off

If no operations are performed for about six seconds, all indicators in the viewfinder and rear control panel will turn off, together with the shutter-speed and aperture displays in the control panel on top of the camera. Press the shutter-release button halfway to reactivate the display. Note that when using the portrait-mode shutter-release button, you will need to unlock the button using the lock release.



### 15—Auto Meter-Off Delay ( pg. 168)

The time delay for automatic meter switch-off can be set to four, six, eight, or sixteen seconds using Custom Setting 15.

## 2—Attaching a Lens

To take full advantage of the complete range of camera features, we recommend that you use a type G or D AF Nikkor CPU lens.

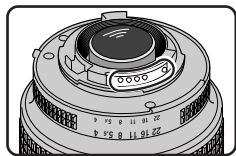

CPU lenses have CPU contacts.

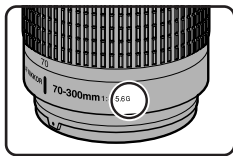

Type G lens

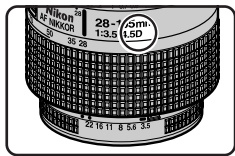

Type D lens

### 2.1 Attach a lens to the camera body

Turn the camera off before attaching or removing lenses (A). Keeping the mounting mark on the lens aligned with the mounting mark on the camera body, position the lens in the camera's bayonet mount and then, being careful not to press the lens-release button, rotate the lens counter-clockwise until it locks into place (B).

If no lens is attached, or if the lens mounted on the camera is not a CPU lens, **F -** will appear in the aperture display in the viewfinder and the control panel on top of the camera when the camera is turned on. If the exposure mode is set to programmed auto or shutter-priority auto, the exposure-mode indicator will blink to warn that the camera will in fact function as though set to aperture-priority auto.

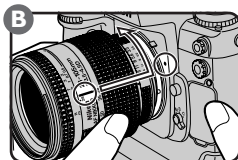
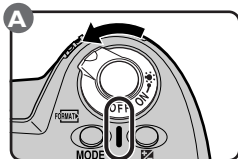

When attaching or removing the body cap or lenses, care should be observed to prevent dirt or other foreign substances from entering the camera body. The presence of foreign bodies inside the camera could affect your photographs. When changing lenses or replacing the body cap, hold the camera with the base down or tilted so that the lens mount faces the ground. Be sure to replace the body cap when no lens is in place.



**For more information on:**

pg. 198 Compatible lenses

## 2.2 Set the lens aperture to the minimum setting

You will not need to perform this step if you are using a type G lens (type G lenses are not equipped with an aperture ring). If you are using another type of lens, set the lens aperture to the highest f-number (minimum aperture). If you do not intend to set aperture manually with the lens aperture ring, lock aperture at this setting (B).

If the lens is not set to the minimum aperture when the camera is turned on, a blinking **FE E** indicator will be displayed in the viewfinder and in the control panel on top of the camera. Photographs can not be taken while this indicator is displayed.

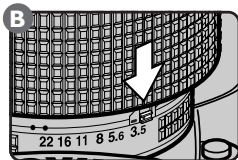
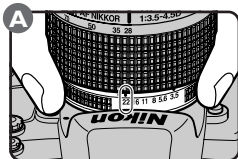

### ✓ When No Lens Is in Place

When no lens is in place, cover the lens mount with the BF-1A body cap supplied with the camera. If the lens mount is not covered, dust may find its way onto the mirror or viewfinder screen.

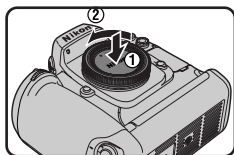

### ✎ Detaching the Lens

After confirming that the camera is off, turn the lens clockwise while holding down the lens-release button.



### CSM 22—Aperture Setting (pg. 173)

By default, aperture is set automatically by the camera or (when the exposure mode is set to manual or aperture-priority auto) using the sub-command dial. Custom Setting 22 allows aperture to be set manually using the lens aperture ring.

## 3—Inserting a Memory Card

In place of film, your Nikon digital camera uses CompactFlash memory cards to store photographs. This step provides instructions on inserting and formatting memory cards. When purchasing memory cards for use in your camera, refer to the list of approved cards in “Technical Notes: Optional Accessories.”

### 3.1 Open the card slot cover

Before inserting or removing memory cards, be sure that the camera is off (A). Open the door protecting the card-slot cover release button (B1) and press the card-slot cover release button (B2) to open the card slot (B3).

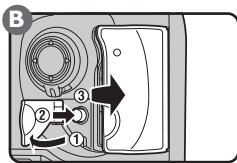
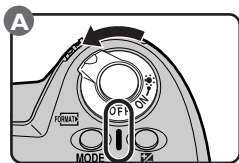

### 3.2 Insert the memory card

Slide the memory card into the card slot (A), stopping when the card terminals are fully inserted in the connectors at the back of the slot. The card should be inserted with the label facing the **▲ CARD** indicator at the entrance to the card slot. After the card is fully inserted, fold the eject button over and close the cover (B).

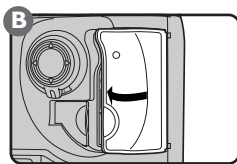
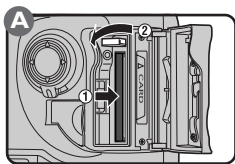

Do not attempt to insert the memory card upside down or back to front, or use force when inserting the card. Failure to observe these precautions could damage the camera or card.



**For more information on:**

pg. 203 Approved memory cards



Memory cards may be hot after use. Observe due caution during removal.



### Format the memory card

Memory cards must be formatted before first use. To format the memory card, turn the camera on (A) and hold the **FORMAT** buttons down together for more than two seconds (B) (to exit without formatting the card, press any other button). A blinking **For** (format) indicator will appear in the control panel on top of the camera (C). To format the memory card, press the **FORMAT** buttons a second time. Note that formatting memory cards permanently deletes any data they may contain. Before formatting a card, be sure to make copies of data you would like to keep.

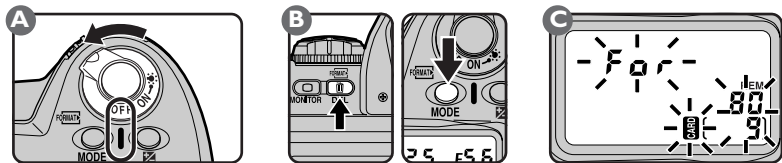

When formatting is complete, the frame-number display in the control panel on top of the camera will show **1**, and the maximum number of shots that can be stored on the card at current settings will be shown in both control panels (if more than a hundred exposures can be stored on the card, the display will show **FL**).



### Removing the Memory Card

Memory cards can be removed without loss of data when the camera is off. Turn the camera off and confirm that the access lamp is off.

*Do not attempt to remove the card while the access lamp is on;* failure to observe this precaution could result in loss of data or in damage to the camera or card.

Open the card slot cover, stand the eject button up (A), and press it down (B1) to eject the card (B2).

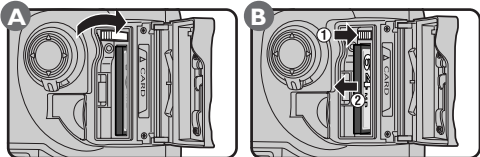

### Format (pg. 143)

Memory cards can also be formatted using the **Format** option in the setup menu.



## 4—Choosing a Language

Camera menus and messages can be displayed in English, French, German, and Japanese. Before setting the time and date, choose a language for the camera menus as described below.

### 4.1 Display the camera menus

Turn the camera on (A) and press the **MENU** button (B). The menu for the current operating mode will be displayed in the monitor (C).

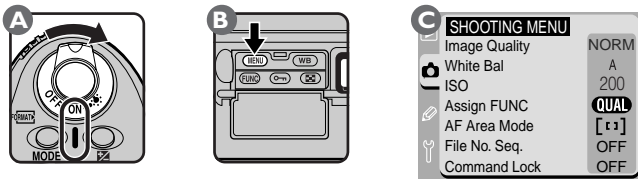

### 4.2 Display the SETUP menu

Unlock the multi selector and press it up or down (A) until the SETUP menu is displayed (B).

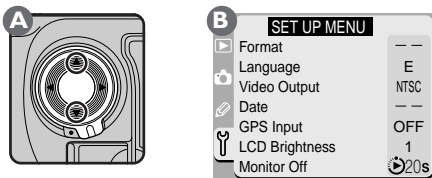

### 4.3 Highlight Language

Press the multi selector to the right to enter the SETUP menu, then press the multi selector down until the second item from the top is highlighted (depending on the language currently selected, the second item from the top will include the word **Language** or **LANG**).

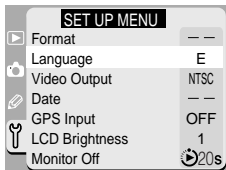

#### 4.4 Choose a language

Press the multi selector to the right to display the **Language** menu, then press the multi selector up or down until the desired language is highlighted. Press the multi selector to the right to put your choice into effect and return to the SETUP menu.



## 5—Setting the Time and Date

The time and date is recorded whenever a photograph is taken. To ensure that the correct information is recorded, set the camera's internal clock-calendar to the current time and date before using the camera for the first time.

### 5.1 Display the camera menus

Turn the camera on (A) and press the **MENU** button (B). The menu for the current operating mode will be displayed in the monitor (C).

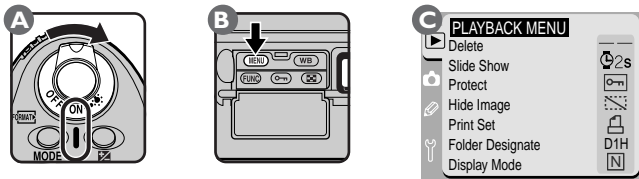

### 5.2 Display the SETUP menu

Unlock the multi selector and press it up or down (A) until the setup menu is displayed (B).

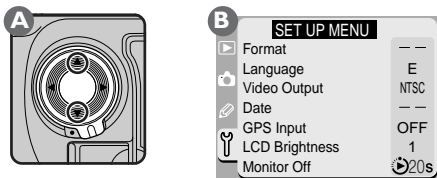

### 5.3 Display the Date menu

Press the multi selector to the right to enter the setup menu, then press the multi selector up or down to highlight **Date**. Press the multi selector to the right to display the **Date** menu.

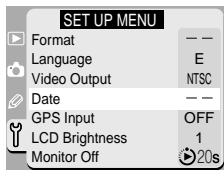

## 5.4 Edit the date and time

Edit the selected item by pressing the multi selector up or down. Press the multi selector to the right to highlight the year; month, date, hour, minute, or second in blue.

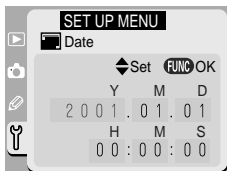

## 5.5 Exit the Date menu

To save changes to settings and return to the SETUP menu, press the **FUNC** button.

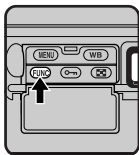

## The Clock Battery

The clock-calendar is powered by an independent battery with a life of about ten years. When no charge remains, the clock battery indicator (**CLOCK**) will appear in the control panel on top of the camera. This will not affect camera operation, but the correct time and date will no longer be displayed. Take the camera to a Nikon-authorized service center, where the battery can be replaced for a fee.















The time and date can also be set using the BKT and  buttons in combination with the main command dial. For details, see “Technical Notes: Specifications.”



















# Taking Photographs

Now that you have set up your camera, you are ready to take photographs. This section describes how to take photographs using autofocus and programmed auto-exposure for “point-and-shoot” photography that produces optimal results in most situations, with no delay between shots to adjust camera settings. Additional information is available in the “Reference” section, as shown in the following chart.

## TUTORIAL: TAKING PHOTOGRAPHS

STEP 1	Adjusting Camera Settings .....  pp. 36–42	
STEP 2	Framing a Photograph .....  pg. 43	
STEP 3	Focusing .....  pp. 44–45	
STEP 4	Checking Exposure .....  pg. 46	
STEP 5	Shooting .....  pg. 47	
STEP 6	Checking the Results .....  pp. 48–50	

## SEE ALSO

- ▶ • Operating Mode ..  pp. 52–55
- ▶ • Sensitivity .....  pp. 62–63
- ▶ • Focus .....  pp. 70–81
- ▶ • Exposure .....  pp. 84–102
- ▶ • Image Quality ....  pp. 56–61
- ▶ • White Balance ..  pp. 64–69
- ▶ • Metering .....  pp. 82–83
- ▶ • Depth-of-Field Preview .....  pg. 106
- ▶ • Technical Notes: Optional Accessories .....  pp. 198–207
- ▶ • Focus .....  pp. 70–81
- ▶ • Depth-of-Field Preview .....  pg. 106
- ▶ • Focal Plane Position .....  pg. 107
- ▶ • Metering .....  pp. 82–83
- ▶ • Exposure .....  pp. 84–102
- ▶ • Self-Timer Modes .....  pg. 103
- ▶ • Playback Options .....  pp. 120–121
- ▶ • Basic Playback .....  pp. 122–133
- ▶ • Playback Menu Options .....  pp. 134–142

## 0—Before You Begin

Before taking a photograph with a new camera, be sure you have completed the following steps:

## 0.1 Turn the camera on and check the battery level

When the camera is turned on (A), the battery level is shown in the control panel on top of the camera (B). Check the battery level as described in Step 1 of “First Steps” (📖 pg. 36).

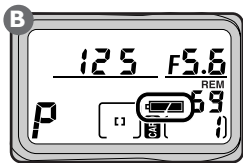
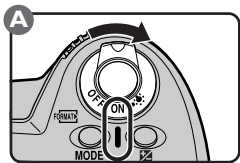

## 0.2 Check the number of exposures remaining

The number of photographs that can be stored on the memory card at current settings is shown in the top.

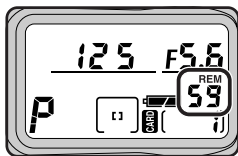

When this number reaches zero, the **Cd** (card) indicator in the viewfinder and the **CARD** icons in the top and rear control panels will blink. Before you will be able to take more photographs, you will need to delete some photos or insert another memory card. You may also be able to take additional photographs at a different image-quality setting.

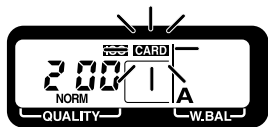
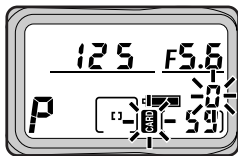

### 0.3 Adjust viewfinder diopter

Your Nikon camera is equipped with diopter adjustment to accommodate individual differences in vision. To adjust viewfinder diopter, pull the diopter knob out (1) and rotate it (2) until the focus brackets in the viewfinder are in sharp focus. Once you have adjusted diopter to your satisfaction, push the diopter knob back into the body of the camera.

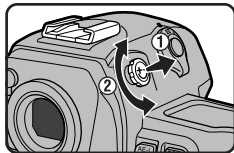

### Reset camera settings

When using the camera for the first time, you may want to clear changes to camera and custom settings made by previous users. After turning the camera on, you can restore settings to defaults by holding the **FUNC** and **☒** buttons down together for more than two seconds (two-button reset). For more information on performing a two-button reset, see “Custom Settings and Other Camera Menus: Two-Button Reset” (📖 pg. 184).

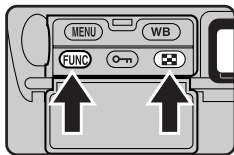

### Frame Count

The frame number shown in the frame count display in the control panel on top of the camera corresponds to the number of photos in the current folder on the memory card. The frame count returns to 1 when a new folder is created.



### 35—Rear Control Panel Display (📖 pg. 183)

When **Frame Count** is selected for Custom Setting 35, the number of exposures remaining will also be shown in the rear control panel.

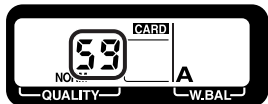

### For more information on:

- pg. 23 Checking the battery level
- pg. 184 Resetting camera settings
- pg. 104 Adjusting viewfinder diopter
- pg. 140 Creating new folders
- pg. 129 Deleting images
- pg. 56 Image quality



# 1—Adjusting Camera Settings

This section describes how to take a photograph using single-frame mode, single-servo autofocus, matrix metering, programmed auto-exposure, a sensitivity (ISO equivalency) setting of 200, a normal image quality setting, and auto white balance. The description below assumes that you are using a type G or D AF-Nikkor lens. These settings will produce optimal results in most situations, with no delay between exposures to adjust camera settings for the next shot. To use these settings, adjust camera controls as shown in the following steps. More information on the settings described here is available on the pages listed below.

## 1.1 Choose an operating mode (pp. 52–55)

Hold the mode-dial lock release down and turn the mode dial to S (single-frame mode). In this mode, the camera will take a single photograph each time the shutter-release button is pressed.

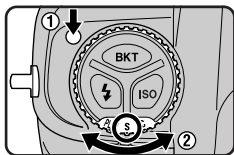

## 1.2 Choose an image quality and format (pp. 56–61)

This section describes how to take color photographs at an image quality of **JPEG Normal**, which provides the best trade-off between file size and image quality.

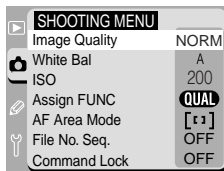
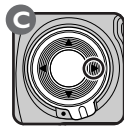
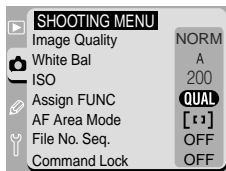
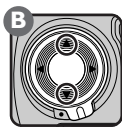
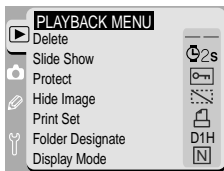
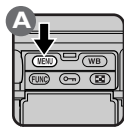

Press the **MENU** button to display the camera menus (A), then unlock the multi-selector and press it up or down until the shooting menu is displayed (B). Press the multi-selector to the right to enter the shooting menu (C).



### The Assign FUNC Menu (pg. 116)

When **Qual** is selected in the **Assign FUNC** menu, image quality can be adjusted using the **FUNC** button in combination with the command dials.

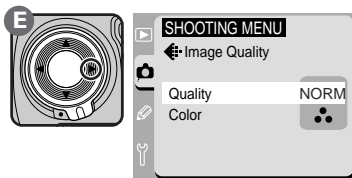

Highlight **Image Quality** (D) and press the multi selector to the right to display the Image Quality menu (E).



Highlight **Quality** (F) and press the multi selector to the right to display the Quality menu (G).



Highlight **JPEG Normal** (H) and press the multi selector to the right to put your choice into effect and return to the Image Quality menu (I).

## 1—Adjusting Camera Settings (continued)

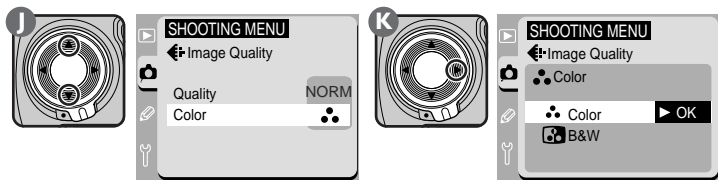

Repeat C–D to display the Image Quality menu, then highlight **Color** (J) and press the multi selector to the right to display the Color menu (K).

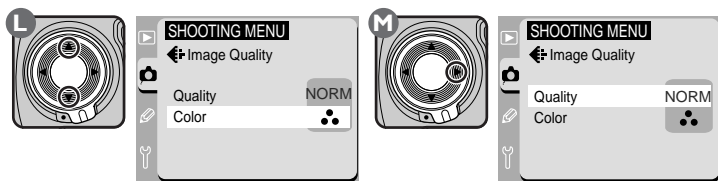

Highlight **Color** (L) and press the multi selector to the right to put your choice into effect and return to the Image Quality menu (M). Press the **MENU** button to return to the shooting menu.

### 1.3 Adjust sensitivity (ISO equivalency) (pp. 62–63)

Holding the ISO button down (A), turn the main command dial (B) until **200** is shown in the top and the rear control panel (C). This sets the sensitivity (the digital equivalent of film speed) to a value roughly equivalent to ISO 200.

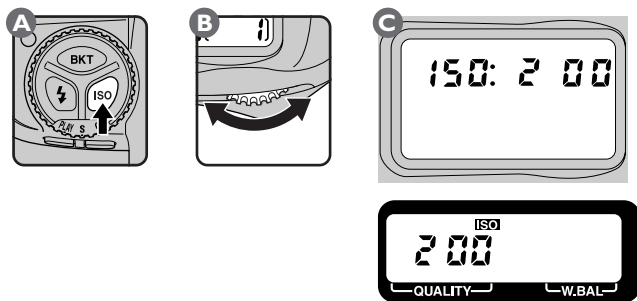

#### 1.4 Choose a white-balance setting (📷 pp. 64–69)

Holding the **WB** button down (A), turn the main command dial (B) until **A** (auto white balance) is shown in the rear control panel (C). At this setting, the camera will automatically adjust white balance to produce good results for most common light sources.

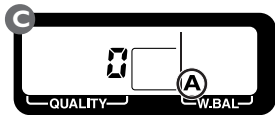
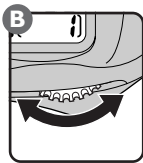
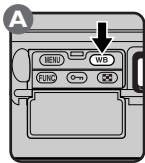

#### 1.5 Choose a focus mode (📷 pp. 70–71)

Turn the focus-mode selector until it clicks into place pointing to **S** (single-servo autofocus). The camera will automatically focus on the subject in the selected focus area when the shutter-release button is pressed halfway. Photographs can only be taken when the camera is in focus. Do not attempt to adjust focus using the lens focusing ring.

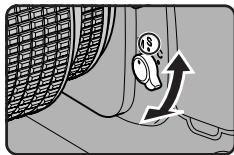

## 1—Adjusting Camera Settings (continued)

## 1.6 Choose the AF-area mode ( pp. 74–77)

Set the AF-area mode to single-area AF using the shooting menu as described below.

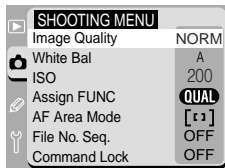
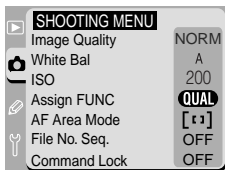
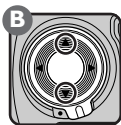
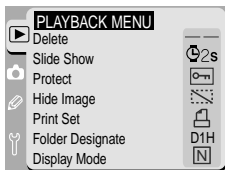
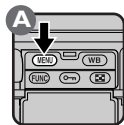

Press the **MENU** button to display the camera menus (A), then unlock the multi-selector and press it up or down until the shooting menu is displayed (B). Press the multi-selector to the right to enter the shooting menu (C).

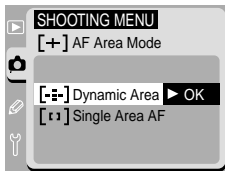
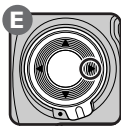
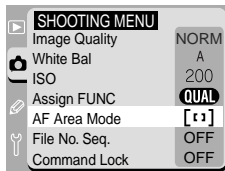
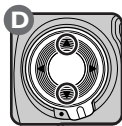

Highlight **AF Area Mode** (D) and press the multi-selector to the right to display the AF Area Mode menu (E).

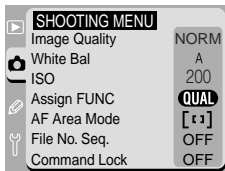
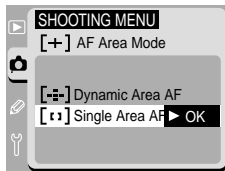
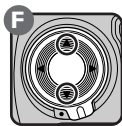

Highlight **Single Area AF** (F) and press the multi-selector to the right to put your choice into effect and return to the shooting menu (G). Press the **MENU** button to clear the menu from the monitor.

## 1.7 Select a focus area (👁️ pg. 73)

Unlock the multi selector (A) and press it up and down, left and right until the center focus area is selected in the viewfinder and the control panel on top of the camera (B). Return the multi selector lock to the locked position.

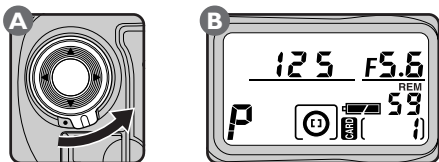

## 1.8 Choose a metering method (👁️ pp. 82–83)

Keeping the metering-selector lock-release held down (A-1), turn the metering selector to  (matrix metering; A-2). The matrix-metering indicator will appear in the viewfinder (B). Matrix metering uses information from all areas of the frame to determine exposure, producing the best possible exposure for the entire frame.

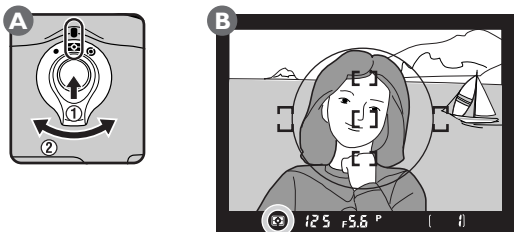

## The Assign FUNC Menu (👁️ pg. 116)

When **AF Area** is selected in the **Assign FUNC** menu, AF-area mode can be adjusted using the **FUNC** button in combination with the main command dial.

## 1—Adjusting Camera Settings (continued)

## 1.9 Choose an exposure mode (📷 pp. 84–95)

With the MODE button held down (A), turn the main command dial (B) until the exposure-mode indicator in the top control panel shows **P** (programmed auto exposure; C). The camera will automatically adjust shutter speed and aperture to produce the optimal exposure for your subject. Exposure is set according to the camera's exposure program.

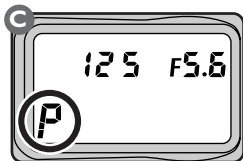
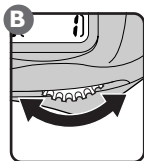
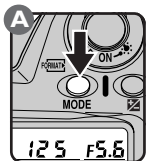
**Non-CPU Lenses**

Programmed auto exposure is only available when a CPU lens is used. When a non-CPU lens is mounted on the camera, the exposure mode will automatically be set to aperture-priority auto. The exposure-mode indicator in the top control panel will show a flashing **P**, the exposure-mode indicator in the viewfinder, **A**. Aperture will be shown in the control panel and viewfinder as **F - -**. Aperture must be set manually using the lens aperture ring.

## 2—Framing a Photograph

When framing photographs, hold the camera as shown below, with your elbow propped lightly against your torso for support. Hold the hand-grip in your right hand and cradle the camera or lens with your left. The shutter-release button for portrait photographs can be used when the camera is in vertical shooting (B).

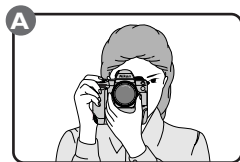

The recommended stance for taking photographs is with one foot a half-pace in front of the other and your upper body in a stable position.



Avoid taking photographs with the camera focused on the sun or other strong light source. Intense light may cause deterioration in the charge-coupled device (CCD) that the camera uses in place of film. It may also produce a white blur effect in the final photograph.



### Shutter Speed and Camera Shake

To prevent blurring caused by camera shake, the shutter speed should be faster than the inverse of the focal length of the lens, in seconds (for example, if the lens has a focal length of 50 mm, shutter speed should be faster than  $1/50$  s). Use of a tripod is recommended when shooting at slower shutter speeds.





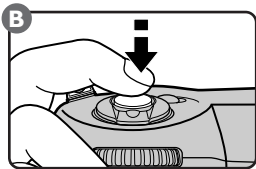

## STEP 3

# 3—Focusing

In single-servo AF, the camera focuses on the subject in the selected focus area when the shutter-release button is pressed halfway. Center the focus brackets on your subject (A) and press the shutter-release button halfway (B).



The camera will adjust focus automatically, and the results of the autofocus operation will be displayed in the viewfinder.

Viewfinder Display	Meaning
	The subject is in focus.
	The camera is focused on an area between camera and subject.
	The camera is focused on an area behind the subject.
	The focus indicator flashes to warn that the camera is unable to focus using autofocus. For more information on what to do when the camera can not focus using autofocus, see “Getting Good Results with Autofocus” (  pg. 80).



The viewfinder shows approximately 96% of the image actually exposed on the CCD. The area that appears in the final photo will be slightly larger than the scene visible through the viewfinder.



**For more information on:**

pg. 73 Focus-area selection

pg. 78 Focus lock

pg. 104 Viewfinder diopter

## 4—Checking Exposure

When the shutter-release button is pressed halfway, the camera will automatically adjust shutter speed and aperture for optimal results. Check the shutter speed and aperture indicators in the viewfinder before shooting. If the photo will be over- or under-exposed, one of the following indicators will appear in the viewfinder and in the control panel on top of the camera.

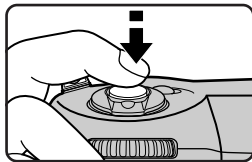

Indicator	Meaning
<b>HI</b>	Photo will be overexposed. Use a neutral density (ND) filter.
<b>Lo</b>	Photo will be underexposed. Use a flash.



### 2—EV Steps for Exposure Control (pg. 161)

By default, aperture and shutter speed are shown in the smallest possible increments. Use Custom Setting 2 to change the size of the increments used when displaying aperture, shutter speed, and exposure compensation.

Press the shutter-release button smoothly all the way down to take a photograph.

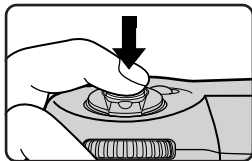

While the photograph is being recorded to the memory card, the card access lamp will light. Do not eject the memory card, turn the camera off, remove the battery, or unplug the AC adapter (available separately) until the lamp has stopped blinking. Removing the card or cutting power in these circumstances could result in loss of data.



Your camera is equipped with a combined electronic (CCD) and mechanical shutter. This shutter operates on a different principle from the mechanical shutters found in film cameras. As a result, the interval between the sounds made by the shutter and mirror will not decrease past a certain point, even at high shutter speeds.



### 1—Image Review (📷 pg. 161)

Using this setting, you can choose whether images are displayed automatically in the LCD monitor while they are recorded to the memory card, or if images are only displayed when the  button is pressed.

## 6—Checking the Results

Photographs stored on the memory card can be displayed at the touch of a button, even when the camera is not in playback mode. This allows the results of a photograph to be confirmed almost instantly. If you are not satisfied with the photograph, you can adjust settings and take another shot. Any shots you do not want to keep can be deleted immediately.

### 6.1 Turn the monitor on

Press the  button to turn the monitor on (A). The most recent photograph will be displayed in the monitor (B).

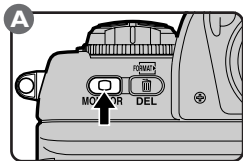

If the memory card contains no photographs, the message, "No image in current folder" will be displayed. Press the  button to turn the monitor off.

### 6.2 Select a photograph

To view the other photographs in memory, press the multi selector up or down. Press up to view photographs taken before the current photograph, down to view photographs taken after the current photograph. Keep the multi selector pressed to scroll rapidly to the desired frame number. When the last photograph taken is selected, pressing the multi selector down will display the first photograph on the memory card. Pressing the selector up when the first image in memory is selected will display the most recent photograph.

#### The Button

If you press the  button to turn the monitor on after taking a photograph, the most recent photograph will be displayed. If you turned the monitor off with the menus displayed, however, the menus will be displayed when you next turn the monitor on.

#### 18—Monitor Off Delay ( pg. 170)

By default, the monitor will turn off automatically to save power if no operations are performed for twenty seconds. Custom Setting 18 can be used to adjust the length of time before the monitor turns off automatically.

If the card contains multiple images, you may find it convenient to select the image you wish to view from a menu of thumbnail images, rather than scrolling through the photos one frame at a time. Turn the main command dial while holding down the  button to cycle through views as follows: single-frame  $\leftrightarrow$  four-thumbnail display  $\leftrightarrow$  nine-thumbnail display  $\leftrightarrow$  single-frame.

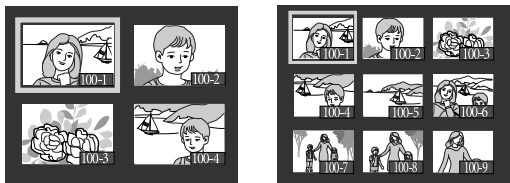

### 6.3 Zoom in on the selected photograph

To zoom in on the selected thumbnail or on the photograph displayed in single-frame review, press the **FUNC** button (A). The center portion of the photograph will be enlarged to fill the monitor (B).

To view other areas of the photo, press the multi selector. To cancel zoom and return to normal review, press the **FUNC** button a second time.

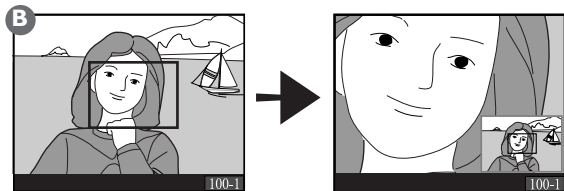
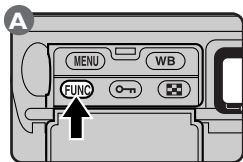

For approximately two seconds after you press the **FUNC** button to zoom in on the image, or after you press the multi selector to scroll the image, a thumbnail showing your current position in the image will appear in the bottom right corner of the display.

## 6—Checking the Results (continued)

## 6.4 View photo information on the selected photograph

To view photo information on an image displayed in single-frame review, press the multi selector right or left (to learn more about the photo information display, see “Reference: Playback”).

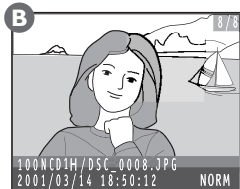
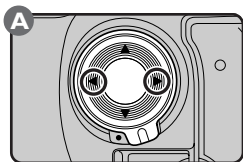

## 6.5 Delete undesired photographs

In single-frame or thumbnail review, pressing the button (A) selects the current image for deletion. A confirmation dialog will be displayed (B), press a second time to delete the photograph and return to single-frame or thumbnail review. Pressing any other button cancels the delete operation, leaving the selected photograph untouched.

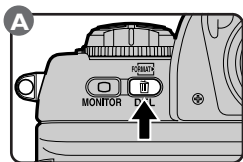

## 6.6 Return to shooting mode

Pressing the button at any time during review turns the monitor off and returns the camera to shooting mode. Pressing the shutter-release button halfway also turns the monitor off and readying it for the next shot.

## REFERENCE

- ***Advanced Photography***  
..... pp. 52–119
- ***Playback*** ..... pp. 120–147
- ***Connecting to a Computer***  
..... pp. 148–154

---

### About This Section

---

This section covers details of photography, playback, and connecting your camera to a computer.

---



## Shooting Modes

Using the mode dial, you can choose between single-frame, continuous, and self-timer modes.

To choose an operating mode, press the mode-dial lock button and turn the mode dial to the desired setting.

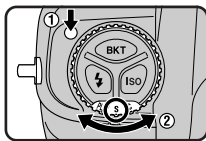

The following modes are available for shooting photographs:

Mode	Description
<b>S</b> Single-frame	The camera takes one photograph each time the shutter-release button is pressed. The card access lamp will light while photographs are being recorded to the memory card. While photographs are being saved, any new photographs will be stored in a temporary memory buffer before being saved to the card. When this buffer is full, the shutter release will be disabled until enough memory is available in the buffer for the next photograph.
<b>C</b> Continuous	Photographs are taken at a maximum rate of approximately five frames per second while the shutter-release button is held down. Photographs are stored in a temporary memory buffer, which can hold a maximum of forty photographs. Additional photographs can be taken as soon as sufficient memory is available in the buffer. A maximum of forty photographs (or twenty-seven images at an image-quality setting of RAW) can be taken before the buffer fills.
 Self-timer	Use this mode to reduce blurring caused by camera shake or to appear in photographs you take yourself.



### Shooting Speed (Continuous Mode)

The rate of approximately three frames per second quoted above is the average obtained at a temperature of 20 °C (68 °F) using continuous-servo AF, manual exposure, a shutter speed of  $1/250$  s or faster, and an aperture smaller than the maximum aperture.

## Remaining Exposures (Continuous Mode)

When the shutter-release button is pressed halfway in continuous mode, the number of consecutive photographs that can be taken before the buffer fills is displayed in the control panel on top of the camera. This indicator shows forty when the buffer is empty, and is reduced by one for each photograph in the buffer. Note that depending on the amount of memory remaining on the memory card, the maximum number of photographs that can be taken in a single sequence may be less than forty. In single-frame mode, this indicator shows the number of exposures remaining.

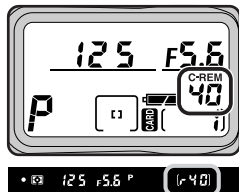

## ✓ Turning the Camera Off

Do not remove the memory card from the camera while images are being transferred from the buffer to the card (if the buffer contains forty photographs, at least 55 seconds will be required). Failure to observe this precaution could result in loss of data or in damage to the camera or the card. If power switch is turned to the off position while data remain in the buffer, the camera will turn off once the image that is currently being written to the card has been saved. **Any other images remaining in the buffer will be lost.** If the battery is exhausted while photographs are being shot in continuous mode, the shutter release will be disabled and all photographs in the buffer will be recorded to the memory card.

The length of time required to record photographs to a Nikon EC-96CF (96-MB) CompactFlash card is shown in the following table:

Image quality	File format	Approximate recording time
High	YCbCr-TIFF	230 s (17 frames)
	RGB-TIFF	235 s (12 frames)
	RAW (uncompressed)	235 s (23 frames)
	RAW (compressed)	180 s (23 frames)
JPEG Fine	JPEG (1 : 4)	130 s (40 frames)
JPEG Normal	JPEG (1 : 8)	85 s (40 frames)
JPEG Basic	JPEG (1 : 16)	55 s (40 frames)

\*The rate at which images are recorded varies with the make of memory card used.

---

**CSM 25—C-Mode Shooting Speed** (👁️ pg. 176)

---

The rate the camera takes photographs in continuous mode can be adjusted using Custom Setting 25.

---

**CSM 26—C-Mode Max Shots** (👁️ pg. 176)

---

Using Custom Setting 26, the maximum number of shots that can be taken in a single sequence in continuous mode can be set to any value between one and forty (or between one and twenty-seven in RAW mode).

The image quality setting controls image quality and image format, which includes image type (color or black-and-white).

Image quality settings can be chosen from the image-quality sub-menu, which can be displayed by highlighting **Image Quality** in the shooting menu and pressing the multi-selector to the right.



The following options are available:

Option	Description
<b>Quality</b>	Choose the amount photographs will be compressed. Four options are available: High, JPEG Fine, JPEG Normal, and JPEG Basic. Selecting High gives you a further choice of two or (depending on the option selected in Custom Setting 28) three file formats: YCbCr-TIFF, RGB-TIFF, and RAW.
<b>Color</b>	Choose whether images will be recorded in color or in black-and-white.

## Choosing the Compression Ratio

Highlighting **Quality** in the image-quality menu and pressing the multi-selector to the right displays a menu of image quality (compression ratio) settings.



The **Quality** menu contains the options listed below.

### High

Highlighting **High** in the image-quality menu and pressing the multi-selector to the right displays a menu of file-format options. High-quality images can be stored as uncompressed TIFF or RAW data or (depending on the option selected using Custom Setting 28) as RAW data compressed using a “lossless” algorithm that has no effect on image quality.

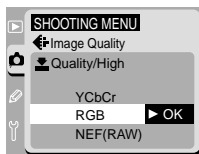

**For more information on:**

The following options are available:

Option	Description
<b>YCbCr</b>	Images are saved in uncompressed YCbCr-TIFF format, where the picture data is represented in one luminance (Y) and two color channels (Cb and Cr). The two color channels occupy the same space as the luminance channel and the file size is therefore two-thirds of the size of an RGB-TIFF file. YCbCr is a more efficient mode of image representation than RGB and has the same quality but occupies less space. Use YCbCr if seeking the best combination of high quality and lowest file size in an uncompressed finished file. This file type can be viewed using Nikon View 4 or Nikon Capture 2.
<b>RGB</b>	Images are saved in uncompressed RGB-TIFF. This file format is supported in a wide variety of imaging applications.
<b>NEF (RAW)</b>	Raw 12-bit data from the CCD are saved directly to the memory card in <b>Nikon Electronic Image Format (NEF)</b> . Files of this type can only be viewed using Nikon Capture 2 or Nikon View 4.

### JPEG Fine

Images are JPEG-compressed at a ratio of approximately 1 : 4.

### JPEG Normal

Images are JPEG-compressed at a ratio of approximately 1 : 8.

### JPEG Basic

Images are JPEG-compressed at a ratio of approximately 1 : 16.

After highlighting an image-quality or file-format option, press the multi selector to the right to return to the Image Quality menu. Press the **MENU** button to return to the shooting menu.



## 28—NEF(RAW) Image Save pg. 178

A setting of RAW is only available if **Uncompressed** or **Compressed** has been chosen from the **NEF(RAW) Image Save** menu (Custom Setting 28). If **Compressed** is chosen, RAW images will be compressed from fifty to sixty percent.

## Choosing the Image Type

Highlighting **Color** in the image-quality menu and pressing the multi selector to the right displays the menu of color options shown at right. Highlight **Color** (for color images) or **B&W** (for black-and-white) by pressing the multi selector up or down. Your choice will have no effect on the number of images that can be recorded to the memory card. The **Color** menu is not available at a setting of **High > NEF (RAW)**.

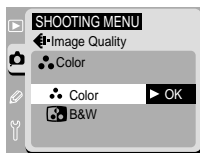

Once you have chosen the image type, pressing the multi selector to the right will return you to the Image Quality menu.

## Understanding the Image-Quality Display

The current image-quality setting is displayed in the rear control panel as shown at right. An image-quality setting of JPEG Normal is shown as **NORM**, a file format of YCbCr-TIFF as **CbCr**, and an image type of black-and-white as **B/W**.

Image type (black-and-white images only)

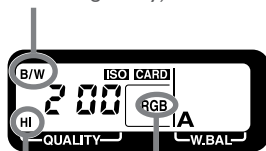

### Image Quality and File Size

The approximate number of images that can be stored on a 96-MB memory card at different combinations of image quality and file format is shown in the following table (image type has no effect on file size and hence bears no relation to the number of images that can be stored on a memory card).

Image quality	File format	Approx. file size	Approx. number of images (96 MB card)*
High	YCbCr-TIFF	5.0 MB	17
	RGB-TIFF	7.5 MB	12
	RAW (uncompressed)	3.8 MB	23
	RAW (compressed)	**	†
JPEG Fine	JPEG (1 : 4)	1.3 MB	66
JPEG Normal	JPEG (1 : 8)	640 KB	132
JPEG Basic	JPEG (1 : 16)	320 KB	265

\* The actual file size (and hence number of images that can be stored on the memory card) JPEG-compressed image will depend on the particular subject and composition. In general the more detail present in an image, the larger the resulting JPEG file.

\*\* Compressed fifty to sixty percent over RAW (uncompressed)

† Although the number of exposures remaining shown in the control panels is the same as for RAW (uncompressed), images are compressed as they are saved, with the result that a larger number of images can be stored on the memory card.



## Using the **FUNC** Button to Set Image Quality

When **Qual** is chosen in the **Assign FUNC** sub-menu, image quality will be assigned to the **FUNC** button, allowing you to adjust image quality without having to access the camera menus.

- 1 Pressing the **FUNC** button (A), rotate the main command dial (B) until the desired image quality (compression ratio) setting is showing in the rear control panel (C).

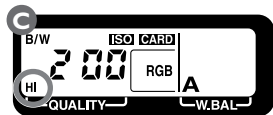
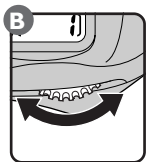
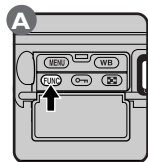

As the main command dial is rotated, settings will change in the order shown below (an image quality of JPEG Normal appears in the rear control panel as **NORM**).

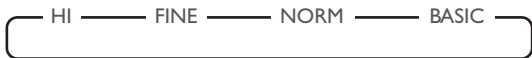

- 2 Pressing the **FUNC** button, rotate the sub-command dial until the desired combination of file format (High image quality only) and image type is shown in the rear control panel.

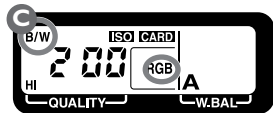
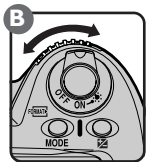
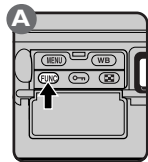

**For more information on:**

pg. 116 The **Assign FUNC** sub-menu

pg. 8 The rear control panel display (image quality)

As the sub-command dial is rotated, image format settings—file format (High image quality only) and image type—will change in the order shown below (a file format of YCbCr-TIFF is shown in the rear control panel as **CbCr**).

### HIGH Image Quality

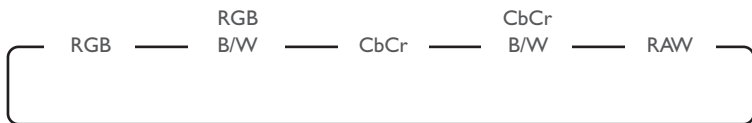

### FINE, NORMAL, BASIC Image Quality



An image type of black-and-white is shown in the rear control panel as **B/W**. If no indicator appears, the image type is color:

## Image File Names

Photographs taken with cameras in the D1 series are saved as image files with a file name of the form “DSC\_nnnn.xxx”, where “nnnn” is a four-digit number from 0001 to 9999 assigned automatically by the camera and “xxx” is a three letter extension (“NEF” for RAW images, “TIF” for RGB-TIFF or YCbCr-TIFF, and “JPG” for JPEG images created at settings of JPEG Fine, JPEG Normal, or JPEG Basic).

## 28—NEF(RAW) Image Save pg. 178

A setting of RAW is only available if **Uncompressed** or **Compressed** has been chosen from the **NEF(RAW) Image Save** menu (Custom Setting 28).

## Sensitivity (ISO Equivalency)

If desired, sensitivity can be altered from the default setting, which is roughly equivalent to ISO 200. Sensitivity can be raised to take photographs in poor light.

### Adjusting Sensitivity with the Button

The sensitivity (ISO equivalency) setting can be adjusted by pressing the ISO button (A) and rotating the main command dial (B). The current sensitivity setting is shown in the top and the rear control panel (C) while the ISO button is pressed.

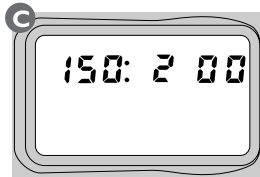
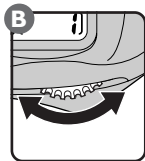
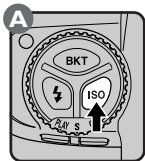

As the main command dial is rotated, settings will change in the order shown below.



### Adjusting Sensitivity from the Shooting Menu

Sensitivity can also be set to ISO equivalents of approximately ISO 200 to ISO 1600 using the **ISO** option in the shooting menu. In the shooting menu, highlight **ISO** and press the multi selector to the right to display a menu of sensitivity settings. Press the multi selector up or down to highlight the desired setting, then press the selector to the right to put your choice into effect and return to the shooting menu.

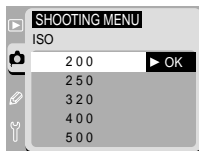

**For more information on:**

## Increased Sensitivity Settings

Note that raising sensitivity increases the amount of “noise” visible in the final photograph.

### 20—ISO Step Value ( pg. 172)

By default, adjustments to sensitivity are made in increments equivalent to  $\frac{1}{3}$  EV ( $\frac{1}{3}$  step). Custom Setting 20 can be used to set the size of the increments to  $\frac{1}{2}$  or 1 step.

$\frac{1}{2}$ -step increments

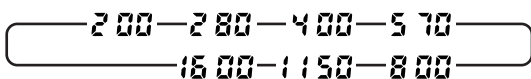

1-step increments

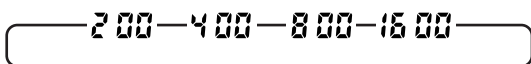

If possible, the current value for sensitivity is maintained when a new ISO step value is selected. If the value currently selected for sensitivity is not available at the new ISO step value, sensitivity will be rounded up to the nearest available setting.

### 31—ISO Boost ( pg. 180)

Sensitivity can be raised by roughly one or two steps over ISO 1600 equivalent. If **ISO** is selected for Custom Setting 35, or if the ISO button is pressed when **Frame Count** is selected, the rear control panel will show **Hi - 1** (sensitivity increased by approximately one step over ISO 1600 equivalent) or **Hi - 2** (sensitivity increased by approximately two steps over ISO 1600 equivalent).



Sensitivity raised by roughly one step (1 EV) over ISO 1600



Sensitivity raised by roughly two steps (2 EV) over ISO 1600

# White Balance

Although the color of light reflected by an object varies with the color of the light source, the human brain is able to adapt to changes in lighting, ensuring that we see white objects as white under most lighting conditions. A digital camera is able to mimic this adjustment so that colors that appear white to the human eye also appear white in your photographs. This adjustment is known as “white balance.”

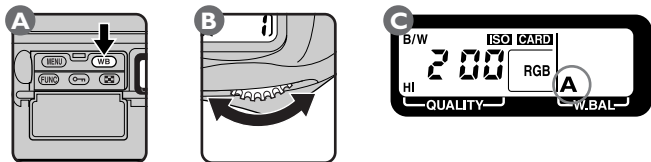

To choose a white balance setting for the current light source, press the **WB** button (A) and rotate the main command dial (B). The current white balance setting will be displayed in the rear control panel (C) while the **WB** button is pressed.



As the main command dial is rotated, settings will change in the order shown below.



Setting	Color temp.	Description
<b>A</b> Auto	4,200–7,000 K (approx.)	White balance adjustment based on color temperature information from a 1,005-pixel CCD sensor.
Incandescent	3,000 K (approx.)	Use when taking photographs indoors under incandescent light.
Fluorescent	4,200 K (approx.)	Use when taking photographs indoors under fluorescent light.
Direct sunlight	5,200 K (approx.)	Use this setting when taking photographs in direct sunlight (daylight).
Flash	5,400 K (approx.)	Use this setting with Nikon Speedlights. With other flashes, use preset white balance.
Cloudy	6,000 K (approx.)	Use when taking photographs under over cast skies (daylight).
Shade	8,000 K (approx.)	Use when taking photographs in the shade under sunny skies (daylight).
<b>PRE</b> Preset	—	Use this setting to match white balance to the light source. The camera can store up to three settings.

Auto white balance (**A**) can be used with most common light sources. To match white balance to a specific light source, select the appropriate setting from the list above. If desired, these white-balance settings (with the exception of preset white balance) can be fine tuned to match a particular light source ( pg. 66). Alternatively, preset white balance ( pg. 67) can be used to set white balance to a measured value.



### Auto White Balance

Auto white balance is adjusted when the shutter-release button is pressed halfway. If you press the shutter-release button all the way down in a single motion, white balance for the first photograph may not accurately match the light source.



### White Balance Measurements

White-balance measurements are performed using a through-the-lens metering system. Even if the subject and camera are under different lighting, the camera will be able to adjust white balance to suit the subject when auto or preset white balance is used.





### Color Temperature

The perceived color of a light source varies with the viewer and other conditions. Color temperature is an objective measure of the color of a light source, defined with reference to the temperature to which an object would have to be heated to radiate light in the same wavelengths. While light sources with a color temperature in the neighborhood of 5,000–5,500°K appear to be white, light sources with a lower color temperature, such as incandescent light bulbs, appear to be slightly yellow or red. Light sources with a higher color temperature seem to be tinged with blue.

## Fine-Tuning White Balance

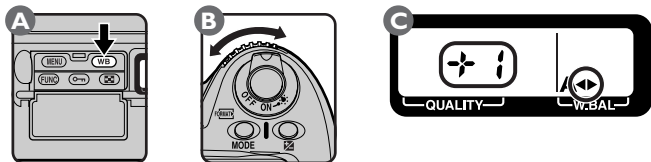
At settings other than **PRE** (preset), white balance can be fine-tuned by pressing the **WB** button (A) and rotating the sub-command dial (B). Adjustments of from  $-3$  to  $+3$  can be made in increments of one.



Lowering white balance gives images a reddish cast, while raising white balance gives images a bluish cast. At settings other than  $\pm 0$ , a  indicator appears in the rear control panel display.

## Adjusting White Balance from the Shooting Menu

White balance can be adjusted using the **White Bal** option in the shooting menu. In the shooting menu, highlight **White Bal** and press the multi selector to the right to display the white-balance menu. Press the multi selector up or down to highlight the desired setting.

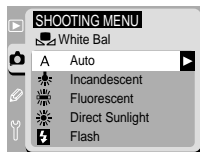

Except in the case of **WB Preset** (preset white balance), highlighting a white balance setting and pressing the multi selector to the right displays a dialog where you can fine-tune the chosen setting. Press the multi selector up or down to choose the amount white balance will be adjusted, then press the multi selector to the right to put your selection into effect and return to the shooting menu.



**For more information on:**

## Preset White Balance

Preset white balance is useful when taking photographs with colored light sources and under other unusual lighting conditions.

### *Recording a Preset White Balance Setting*

- 1 In the shooting menu, highlight **White Bal** and press the multi selector to the right to display the white-balance menu.
- 2 Highlight **WB Preset** and press the multi selector to the right. The menu shown at right will be displayed.
- 3 Highlight **Set** and press the multi selector to the right. The message, "Please release the shutter" will be displayed.

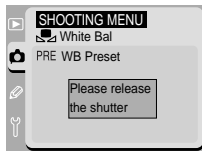
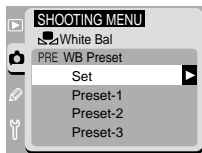
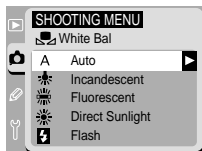



**4** Under the lighting that will be used in the actual photograph, frame a white or neutral gray object so that it fills the viewfinder and then press the shutter-release button all the way down. The shutter will be released and the measured value for white balance stored in camera memory, but no image will be recorded to the memory card.

Note that when performing this operation, it will be necessary to focus the camera using the lens focus ring in manual focusing mode. At a setting of single-servo autofocus, lack of contrast will prevent the camera from focusing on the target object and the shutter release will be disabled. Similarly, auto-exposure (exposure mode **P**, **S**, or **A**) should be used to prevent extreme over- or under-exposure that could interfere with an optimal white balance measurement. White balance can also be set using manual exposure (exposure mode **M**); note, however, that exposure settings that would produce extreme over- or under-exposure can prevent the camera from setting white balance.

**5** The menu shown at right will be displayed in the monitor. The measured value for preset white balance can be saved as your choice of Preset-1, Preset-2, or Preset-3; highlight the desired option and press the multi selector to the right to record the white balance setting and return to the shooting menu. Select **Repeat release** to measure white balance again, or **Cancel** to return to the shooting menu without saving the new value for white balance.

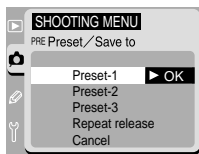

### Measuring White Balance

When measuring white balance under studio lighting, we recommend that a neutral gray object be used as the target. When using a white object, select a setting for exposure that would cause the object to appear gray when photographed to prevent mis-reading caused by overexposure.

### Recalling Preset White Balance

- Recalling preset white balance using the **WB** button

Choose a white-balance setting of Preset (pg. 67), then press the WB button (A) and rotate the sub-command dial (B) until the desired setting is displayed in the rear control panel (C).

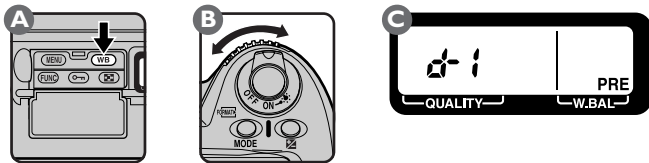

A setting of **d-1** is equivalent to Preset-1, **d-2** to Preset-2, and **d-3** to Preset-3.

- Recalling preset white balance from the shooting menu
- Highlight **WB Preset** in the white-balance menu and press the multi selector to the right. The menu shown at right will be displayed; highlight the desired setting and press the multi selector to the right to put your choice into effect and return to the shooting menu.

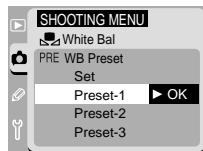

## The Focus-Mode Selector

When the focus mode selector (A) is set to **S** (single-servo autofocus) or **C** (continuous-servo autofocus), the camera focuses automatically when the shutter-release button is pressed halfway (B).

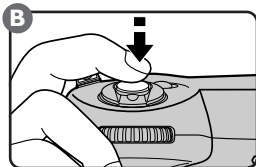
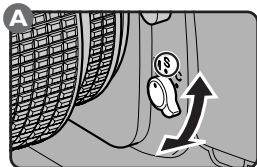

When your subject is stationary, single-servo AF allows you to lock focus on the subject by keeping the shutter-release button pressed halfway (or either of the AF-ON buttons pressed). The camera remains focused at the distance of the original subject as long as the shutter-release button is pressed halfway (or either of the AF-ON buttons held down), even if you re-frame the photograph so that the subject is no longer in the selected focus area. To ensure a sharp image, the shutter can only be released when the camera is in focus.

Continuous-servo AF can be used with moving subjects to allow the camera to continually reassess the distance to the subject in the focus area and adjust focus as necessary. The shutter can be released even when the camera is not in focus (release priority).

In both single-servo and continuous-servo AF, the focus target is selected from one of five focus areas using the multi selector:



**For more information on:**

Focus mode	Description
<b>S</b> Single-servo AF (focus priority)	If the subject is stationary, the camera focuses when the shutter-release button is pressed halfway. Focus remains locked while the shutter-release button is held in this position ( <i>focus lock</i> ). The shutter can only be released when the in-focus indicator (●) is displayed ( <i>focus priority</i> ).
<b>C</b> Continuous-servo AF (release priority)	The camera adjusts focus continuously while the shutter-release button is pressed halfway, automatically tracking moving subjects ( <i>focus tracking</i> ). The shutter can be released at any time, whether or not the camera is in focus ( <i>release priority</i> ). Focus is not locked when the in-focus indicator (●) is displayed.

### The AF-ON Buttons

An alternative means of activating autofocus is to press the AF-ON button (A) or, when the shutter-release button for vertical shooting is unlocked, the AF-ON button for vertical shooting (B). Either operation has the same effect as pressing the shutter-release button halfway.

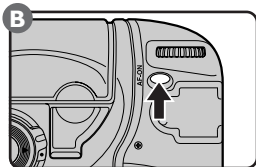
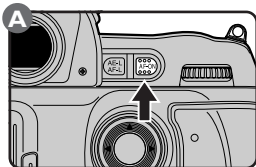

Using this setting, the camera can be programmed so that an autofocus operation can only be performed using the AF-ON buttons to avoid accidental shutter release.

Your Nikon digital camera is equipped with five focus areas that together cover a wide area of the frame. By choosing a focus area according to your composition and the position of your subject, you can focus on an off-center subject without using focus lock.

Unlock the multi selector (A) and use it to choose a focus area. The selected focus area is displayed in the control panel on top of the camera (B) and is briefly highlighted in red in the viewfinder (C).

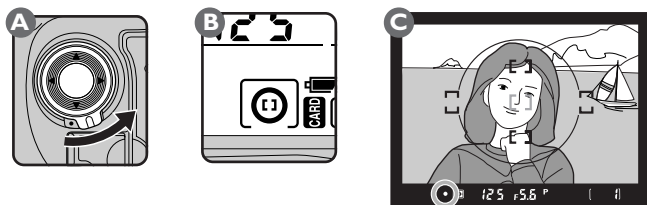

The focus area can be fixed at the chosen setting by rotating the multi selector lock to the locked position.



The focus area can not be changed while images are displayed in the monitor:



Focus-area selection can be used with any type of viewfinder focusing screen.



### 6—Focus Area Select (pg. 163)

At default settings, focus-area selection can only move from the center focus area to the four outer focus areas and back, so that, for example, pressing the multi selector up when the top focus area is selected has no effect. This can be changed so that focus area selection “wraps around,” allowing you to shift the focus area from top to bottom or from right to left without changing the position of your finger on the multi selector.



**For more information on:**

pg. 78 Focus lock

When autofocus is in effect, you can select the AF-area mode depending on whether you want the camera to focus on the subject in a single focus area (single-area AF), or to follow the subject as it shifts from one focus area to the next (dynamic AF).

In single-area AF, the choice of focus area is in your hands. If your subject is moving erratically, or if you are experimenting with a variety of compositions, it may however be difficult or impossible to select the focus area using the multi selector. In cases such as these, dynamic AF can be used to give the camera control over selection of a new focus point.

When dynamic AF is used with single-servo autofocus, the focus area can not be selected using the multi selector. Instead, the camera continually assesses the distance to the objects in all five focus areas, and automatically chooses the focus area containing the object closest to the camera. This combination is useful when your subject is always positioned closest to the camera but you are trying out a number of different camera positions to find the best composition.

When dynamic AF is used in combination with continuous-servo autofocus, the camera measures the distance to the subject in the selected focus area when the shutter-release button is pressed halfway to initiate autofocus. It will continue to focus on this subject as it moves from one focus area to the next. The multi selector can be used at any time to choose a new focus area. This combination is useful when your subject is moving erratically and manual focus area selection is too slow or cumbersome.

## Selecting the AF-Area Mode

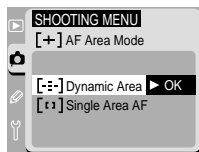

In the shooting menu, highlight **AF Area Mode** and press the multi selector to the right. The menu shown at right will be displayed. Highlight the desired option and press the multi selector to the right to put your choice into effect and return to the shooting menu.



**For more information on:**

pg. 188 The shooting menu

The following options are available:

Icon	Option	Description
	<b>Dynamic Area AF</b>	When the autofocus system is initiated by pressing the shutter-release button halfway or by pressing either of the AF-ON buttons, the camera focuses on the subject in the active focus area. The camera then continuously scans all five focus areas to maintain focus as the subject moves into other focus areas. This mode is useful when it is difficult to predict where the subject will be at the moment of exposure. Unless the focus area is changed using the multi selector, the focus area originally selected will be used as the focus target the next time you initiate autofocus.
	<b>Single Area AF</b>	The camera focuses on the subject in the selected focus area. This mode is effective when focusing on subjects that are relatively motionless.

The current AF-area mode is indicated by the display in the top control panel.

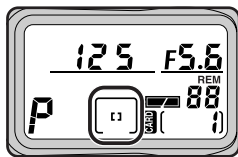

#### Using the **FUNC** Button to Select the AF-Area Mode

When **AF Area** is chosen in the **Assign FUNC** sub-menu, AF-area mode will be assigned to the **FUNC** button, allowing you to select the AF-area mode without accessing the camera menus. Pressing the **FUNC** button (A), rotate the main command dial (B) until the desired AF-area mode is showing in the control panel on top of the camera (C).

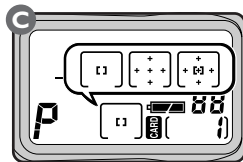
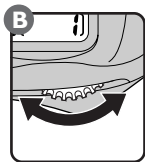
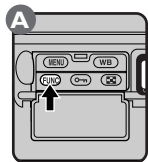





### **Closest-Subject Priority**

Closest-subject priority is available when dynamic AF is selected. When this option is in effect, the camera assesses the distance to the subjects in each of the five focus areas and selects the area containing the subject closest to the camera. It then tracks this subject as it moves from one focus area to the next. As a result the camera maintains focus on the target through to the time when the shutter-release button is pressed. Note that when the subject is poorly lit or a telephoto lens is used, the camera may fail to select the focus area containing the subject closest to the camera. Single-area AF is recommended in these cases.

When closest-subject priority is in effect, no focus-area indicators are shown in the viewfinder or in the control panel on top of the camera.



### **Advanced Options for Dynamic AF**

If desired, closest-subject priority can be deactivated when using dynamic AF with single-servo autofocus, allowing the multi selector to be used to select the focus area. Closest-subject priority can be activated when using dynamic AF with continuous-servo autofocus, causing the camera to re-focus on the closest subject should it lose track of the original subject. These options are only recommended for advanced users who have made the necessary preparations to allow them to take advantage of these combinations.



### **9—Dynamic AF, Single-Servo (pg. 165)**

In single-servo autofocus, the default setting for dynamic AF is closest-subject priority on. To turn it off, use Custom Setting 9.



### **10—Dynamic AF, Continuous-Servo (pg. 165)**







In continuous-servo autofocus, the default setting for dynamic AF is closest-subject priority off. To turn it on, use Custom Setting 10.



### **For more information on:**

pg. 116 The **Assign FUNC** sub-menu

The focus area can not be selected manually when closest-subject priority is in effect (in closest-subject priority, the camera selects the focus area automatically), and consequently focus area indicators are not displayed in the viewfinder or in the control panel on top of the camera. The relationship between AF-area mode and the focus area display is shown in the following table.

Focus mode	AF-area mode	Closest-subject priority	Focus area selection	Control panel display	Focus area shown in viewfinder?
S-AF	Single Area AF	—	Manual		Yes
	Dynamic Area AF	On (default)	Automatic		No
		Off (Custom Setting 9 set to <b>Select AF Area</b> )	Manual		Yes
C-AF	Single Area AF	—	Manual		Yes
	Dynamic Area AF	Off (default)	Manual		Yes
		On (Custom Setting 10 set to <b>Closest Subject</b> )	Automatic		No

Focus lock can be used in combination with autofocus to focus on a subject that is not in any of the five focus areas, or on other occasions when the camera would not otherwise be able to focus using autofocus (👁️ pg. 80).

Focus lock differs depending on whether you are using single- or continuous-servo AF. Follow the steps below.

- 1 Position the subject in the selected focus area (A) and press the shutter-release button halfway (B).

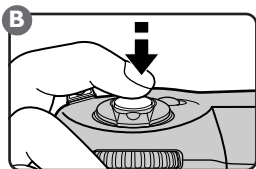
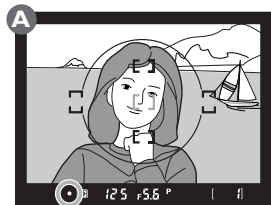

- 2 Lock focus when the in-focus indicator (●) appears in the viewfinder.

- **In single-servo autofocus:**

Once the in-focus indicator has appeared in the viewfinder, focus will lock when the shutter-release button is pressed halfway, and remain locked while the button is held in this position. Focus can also be locked by pressing the AE-L/AF-L button (see below).

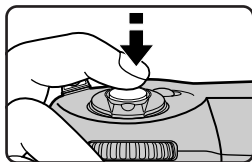

- **In continuous-servo autofocus:**

After the in-focus indicator appears in the viewfinder, press the AE-L/AF-L button to lock both focus and exposure. Focus will remain locked while the AE-L/AF-L button is pressed, even if you remove your finger from the shutter-release button.

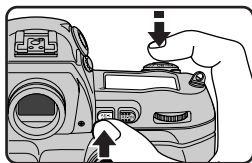

**For more information on:**

3 Keeping focus locked, recompose your photograph (A) and shoot (B).

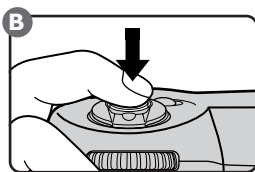
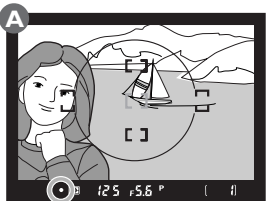

When focus is locked by pressing the shutter-release button halfway, you can take several photographs in succession at the same focus setting by keeping the shutter-release button lightly pressed between each shot. Focus will also remain locked between shots as long as you continue to press the AE-L/AF-L button.

Do not change the distance between the camera and the subject while focus lock is in effect. If your subject moves, focus again at the new distance.

## Getting Good Results with Autofocus

Autofocus does not perform well under the conditions listed below. In these cases you can focus manually (📷 pg. 81) or use autofocus as detailed below.



### *The subject is poorly lit*

Use a Speedlight with an AF-assist illuminator, such as the SB-28DX or SB-50DX (available separately) and select the center focus area.

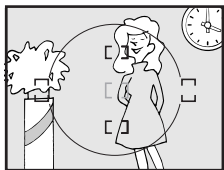

### *There is little or no contrast between the subject and the background*

Lack of contrast—for example, a subject that is the same color as the background—can interfere with autofocus. Use focus lock (📷 pg. 78) to focus on another subject at the same distance and then recompose your photograph.



### *The focus area contains objects at different distances from the camera*

For example, autofocus may not perform well when the subject is inside a cage. Use focus lock (📷 pg. 78) to focus on another subject at the same distance and then recompose your photograph.

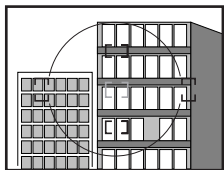

### *The subject is dominated by regular geometrical patterns*

Regular geometrical patterns—for example, a row of windows in a skyscraper—can interfere with autofocus. Use manual focus (📷 pg. 81).

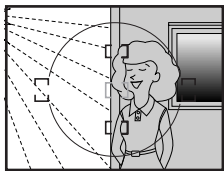

### *The focus area contains regions of sharply differing brightness*

The camera may not be able to focus using autofocus when, for example, the subject is half in the shade. Use manual focus (📷 pg. 81).



Manual focus can be used with lenses that do not support autofocus (non-AF Nikkor lenses) or in situations in which autofocus will not produce the desired results.

## Adjusting Focus in the Viewfinder

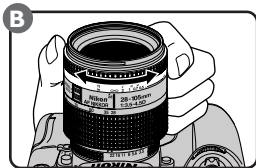
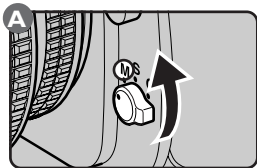
To use manual focus, turn the focus-mode selector (A) to M and turn the lens focusing ring (B) until the image displayed on the clear matte field in the viewfinder is in focus. Photographs can be taken even when the in-focus indicator (●) does not appear in the viewfinder:



## Using the Electronic Range Finder

When a lens with a maximum aperture of  $f/5.6$  or faster is used in manual focus mode, the in-focus indicator (●) can be used to confirm focus in any of the five focus areas. With the focus-mode selector set to M, press the shutter-release button halfway. Before the focus indicator in the viewfinder disappears, rotate the lens focusing ring (A) until the in-focus indicator (●) is displayed in the viewfinder (B). If the  indicator is displayed, the camera is focused on a point between the camera and the subject. If the  indicator appears, the camera is focused on a point behind the subject.

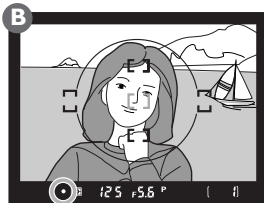

**For more information on:**

pg. 80 Getting good results with autofocus

pg. 73 Focus-area selection

D1H offers a choice of three metering methods, which can be chosen according to how your subject is lit. Note that depending on the lens used, some metering methods may not be available.

To choose a metering method, press the metering selector lock release (1) while rotating the metering selector to the desired setting (2).

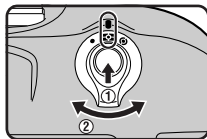

## 14—Center Weight Area (pg. 168)



This option is used to set the size of the area assigned the greatest weight in center-weighted metering to 6 mm (0.24"), 10 mm (0.39"), 13 mm (0.51"), or to the average of the entire frame.



### **For more information on:**

pg. 198 Compatible lenses

The following options are available:

Method	Description
 <p>3D color matrix/ Color matrix</p>	<p>Metering is performed by a CCD sensor with 1,005 metering pixels (67 vertical, 15 horizontal), which sets exposure based on a variety of information from all areas of the frame. This system demonstrates its effectiveness most dramatically where bright (white or yellow) or dark (black or dark green) colors occupy most of the frame, when it produces results approaching what is seen by the human eye. 3D color matrix metering, which makes use of range information from the lens when adjusting exposure, is only available when a type G or D lens is used. When lenses of other types are attached, color matrix metering is used. This setting is not recommended when using auto-exposure lock or exposure compensation; use center-weighted or spot metering instead.</p>
 <p>Center-weighted</p>	<p>The camera measures light over the entire frame, but assigns the greatest weight to a circular area in the center of the frame 8 mm (0.31") in diameter (use the 12 mm/0.47" circle in the center of the viewfinder as a reference for center-weighted metering).</p>
 <p>Spot</p>	<p>The camera measures light in a circle 4 mm (0.15") in diameter centered on the current focus area, occupying approximately two percent of the frame. Spot metering is recommended for backlit subjects, compositions that contains areas of high contrast, and other occasions when you want to limit metering to an area about the size of the focus brackets. Because metering is linked to the current focus area, we recommend that you arrange your composition so that the main subject falls in one of the focus areas and then select that focus area using the multi selector. Note, however, that when closest-subject priority is used or a non-CPU lens attached, metering will be performed in the center focus area only.</p>



### **For more information on:**

- pg. 96 Auto-exposure lock
- pg. 98 Exposure compensation
- pg. 73 Focus area selection
- pg. 76 Closest-subject priority



D1H offers a choice of four manual exposure modes: programmed auto, shutter-priority auto, aperture-priority auto, and manual.

## Programmed Auto

In programmed auto, the camera automatically adjusts shutter speed and aperture according to the exposure program (see opposite) to produce optimal results. This exposure mode is recommended for snapshots and other unplanned situations that require a quick response. Programmed auto can also be used with program shift, auto bracketing (👁️ pg. 100), and exposure compensation (👁️ pg. 98) for more demanding shooting situations. Programmed auto is only available with CPU lenses.

To take photographs in programmed auto:

- 1 Pressing the MODE button, rotate the main command dial until **P** is displayed in the control panel on top of the camera.
- 2 Frame a photograph and shoot.

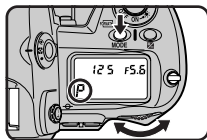

## Lens Aperture Ring

If the lens aperture ring has not been set to the minimum aperture, the viewfinder and control panel on top of the camera will show a blinking **F E E**, and the shutter release will be disabled. This does not apply in the case of type G lenses, which do not have an aperture ring.

## Non-CPU Lenses

If programmed auto is selected when a non-CPU lens is attached, the exposure mode will automatically be set to aperture-priority auto (A). The aperture display in the viewfinder and the control panel on top of the camera will show **F -** - the **P** in the control panel on top of the camera will blink, and the exposure-mode display in the viewfinder will show **A** to indicate that aperture must be set manually using the lens aperture ring.

## Exposure Indicators

If the subject is too bright or too dark to allow correct exposure, one of the following indicators will appear in the viewfinder and the control panel on top of the camera:

- H I** Subject too bright; use an ND filter.
- L O** Subject too dark; use a flash.



## Flexible Program

Programmed auto offers multiple combinations of shutter speed and aperture, each of which will produce the correct exposure, giving you a degree of control over shutter speed and aperture while leaving the camera to set exposure. To choose a new combination of shutter speed and aperture, rotate the command dial (A). While flexible program is in effect, an asterisk (“\*”) will appear next to the exposure-mode indicator in the control panel on top of the camera (B). To restore the default shutter speed and aperture settings, rotate the command dial until the asterisk is no longer displayed. Flexible program is also cancelled when the camera is turned off or a two-button reset (👁️ pg. 184) is performed.

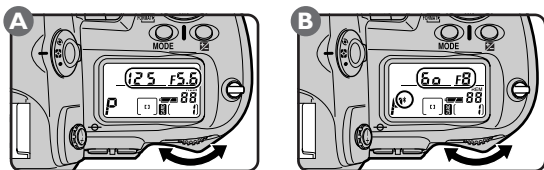

## Exposure Program

The following graph shows the exposure program for programmed auto

ISO 200, lens with maximum aperture of f/1.4 and minimum aperture of f/16 (e.g., AF 50 mm f/1.4D)

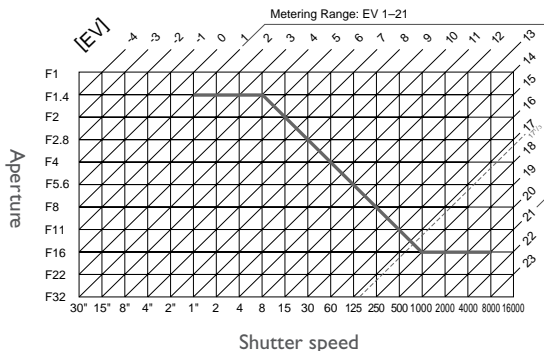

The maximum and minimum values for EV vary with sensitivity (ISO equivalency). Matrix metering reduces to  $17\frac{1}{3}$  any EV that exceeds  $17\frac{1}{3}$  at a sensitivity of ISO 200 equivalent.

### Shutter-Priority Auto

In shutter-priority auto, the user sets the shutter speed, while the camera automatically adjusts aperture to produce the optimal exposure. Shutter speed can be set to values between thirty and 1/16,000 seconds. Use high shutter speeds to “freeze” motion, low shutter speeds to blur moving objects. Shutter-priority auto is only available with CPU lenses.

To take photographs in shutter-priority auto:

- 1 Pressing the MODE button, rotate the main command dial until **S** is displayed in the control panel on top of the camera.
- 2 Rotate the main command dial to choose a shutter speed.
- 3 Frame a photograph and shoot.

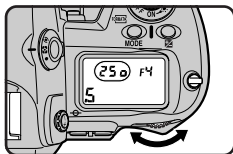
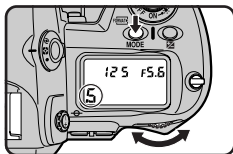

#### Lens Aperture Ring

If the lens aperture ring has not been set to the minimum aperture, the viewfinder and control panel on top of the camera will show a blinking **F-E**, and the shutter release will be disabled. This does not apply in the case of type G lenses, which do not have an aperture ring.



#### Non-CPU Lenses

If shutter-priority auto is selected when a non-CPU lens is attached, the exposure mode will automatically be set to aperture-priority auto (A). The aperture display in the viewfinder and the control panel on top of the camera will show **F-**, the **S** in the control panel on top of the camera will blink, and the exposure-mode display in the viewfinder will show **A** to indicate that aperture must be set manually using the lens aperture ring.

 **Long Time-Exposures**

Noise may appear in photographs taken at speeds of approximately one second or slower.

 **Exposure Indicators**

If the subject is too bright or too dark to allow correct exposure, the electronic analog exposure display will flash and one of the following indicators will appear in the viewfinder and the control panel on top of the camera:

 **Subject too bright; choose a faster shutter speed or use an ND filter.**

 **Subject too dark; choose a lower shutter speed or use a flash.**

 **Shutter-Speed Lock**

Shutter speed can be locked at the selected setting ( pg. 94).

 **2—EV Steps for Exposure Control ( pg. 161)**

By default, adjustments to shutter speed are made in increments equivalent to  $1/3$  EV ( $1/3$  step). If desired, the size of the increments can be increased to  $1/2$  or 1 step.

 **12—Assign Command Dial ( pg. 166)**

This setting can be used to reverse the roles of the command dials so that the main command dial controls aperture while shutter speed is assigned to the sub-command dial.

### Aperture-Priority Auto

In aperture-priority auto, the user sets the aperture, while the camera automatically adjusts shutter speed to produce the optimal exposure. Small apertures (high *f*-numbers) can be used to increase depth of field, bringing both the main subject and the background into focus. Large apertures (low *f*-numbers) soften background details and allow more light into the camera, increasing the range of the flash and making photographs less susceptible to blurring.

To take photographs in aperture-priority auto:

- 1 Pressing the MODE button, rotate the main command dial until **A** is displayed in the control panel on top of the camera.
- 2 Rotate the sub-command dial to choose an aperture between the minimum and maximum values for the lens.
- 3 Frame a photograph and shoot.

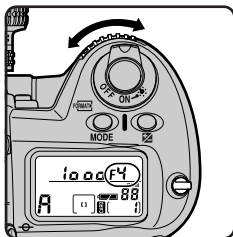
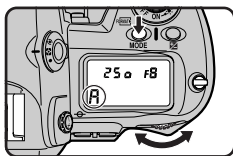

#### Lens Aperture Ring

If the lens aperture ring has not been set to the minimum aperture, the viewfinder and control panel on top of the camera will show a blinking **fE E**, and the shutter release will be disabled. This does not apply in the case of type G lenses, which do not have an aperture ring.





#### Non-CPU Lenses

If aperture-priority auto is selected when a non-CPU lens is attached, the aperture display in the viewfinder and the control panel on top of the camera will show **f -** to indicate that aperture must be set manually using the lens aperture ring.

## Exposure Indicators

If the subject is too bright or too dark to allow correct exposure, the electronic analog exposure display will flash and one of the following indicators will appear in the viewfinder and the control panel on top of the camera:

-  Subject too bright; choose a higher f/-number or use an ND filter.
-  Subject too dark; choose a lower f/-number or use a flash.

## Aperture Lock

Aperture can be locked at the selected setting ( pg. 94).

## 2—EV Steps for Exposure Control ( pg. 161)

By default, adjustments to aperture are made in increments equivalent to  $1/3$  EV ( $1/3$  step). If desired, the size of the increments can be increased to  $1/2$  or 1 step.

## 12—Assign Command Dial ( pg. 166)

This setting can be used to reverse the roles of the command dials so that the main command dial controls aperture while shutter speed is assigned to the sub-command dial.

## 22—Aperture Setting ( pg. 173)

Use this setting when you want to adjust aperture using the lens aperture ring. Note that aperture for type G lenses is always set using the command dials, regardless of the option chosen for Custom Setting 22.

### Manual

In manual exposure, the user controls both aperture and shutter speed. The shutter can be held open indefinitely for a long time-exposure (bulb) or shutter speed set to a fixed value between thirty and 1/16,000 seconds. Aperture can be set to values between the minimum and maximum for the lens. Using the electronic analog exposure display in the viewfinder or the control panel on top of the camera as your guide, you can adjust exposure to suit shooting conditions and the task at hand.

To take photographs in manual exposure mode:

- 1 Pressing the MODE button, rotate the main command dial until **M** is displayed in the control panel on top of the camera.

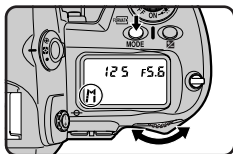

#### Lens Aperture Ring

If the lens aperture ring has not been set to the minimum aperture, the viewfinder and control panel on top of the camera will show a blinking **FE E**, and the shutter release will be disabled. This does not apply in the case of type G lenses, which do not have an aperture ring.

#### Non-CPU Lenses

If aperture-priority auto is selected when a non-CPU lens is attached, the aperture display in the viewfinder and the control panel on top of the camera will show **F-** to indicate that aperture must be set manually using the lens aperture ring.

#### Long Time-Exposures

At a shutter-speed setting of **bulb**, the shutter will remain open as long as the shutter-release button is held down. Note that if the shutter is open for more than approximately one second at any setting, noise may appear in the final photograph.

2 Rotate the main command dial to choose a shutter speed (A). Aperture is set by rotating the sub-command dial (B).

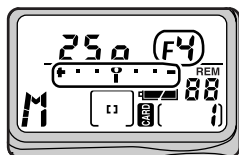
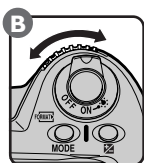
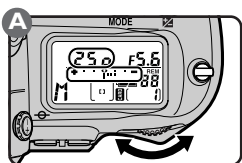









## 2—EV Steps for Exposure Control (pg. 161)

By default, adjustments to aperture and shutter speed are made in increments equivalent to  $\frac{1}{3}$  EV ( $\frac{1}{3}$  step). If desired, the size of the increments can be increased to  $\frac{1}{2}$  or 1 step.



## Exposure Mode (continued)

Check exposure in the electronic analog exposure displays in the viewfinder and in the control panel on top of the camera as shown below (the illustration below shows the display that appears in the control panel on top of the camera). Adjust shutter speed and aperture until the desired exposure is achieved. If the limits of the camera's metering system are exceeded, the electronic analog exposure displays will flash.

Custom Setting 2 (EV steps for exposure control) set to $\frac{1}{3}$ Step	Custom Setting 2 (EV steps for exposure control) set to $\frac{1}{2}$ Step	Custom Setting 2 (EV steps for exposure control) set to 1 Step
Optimal exposure 	Optimal exposure 	Optimal exposure 
Underexposed by $\frac{1}{3}$ EV 	Underexposed by $\frac{1}{2}$ EV 	Underexposed by 1 EV 
Overexposed by more than 2 EV 	Overexposed by more than 3 EV 	Overexposed by more than 3 EV 

3 Frame a photograph and shoot.

---

 **AF Micro NIKKOR Lenses**

---

When the sub-command dial is used to set aperture, the exposure ratio need not be taken into account *provided that an external exposure meter is used*. Compensation that takes the exposure ratio into account is only necessary when the lens aperture ring is used.

---

 **Shutter-Speed and Aperture Lock**

---

Shutter-speed and aperture can be locked at the selected setting ( pg. 94).

---

 **12—Assign Command Dial ( pg. 166)**

---

This setting can be used to reverse the roles of the command dials so that the main command dial controls aperture while shutter speed is assigned to the sub-command dial.

---

 **22—Aperture Setting ( pg. 173)**

---

Use this setting when you want to adjust aperture using the lens aperture ring. Note that aperture for type G lenses is always set using the command dials, regardless of the option chosen for Custom Setting 22.

## Shutter-Speed and Aperture Lock

In shutter-priority auto and manual exposure modes, you can lock shutter speed at the selected value. In aperture-priority auto and manual exposure modes, you can lock aperture at the selected *f*-number. Lock is not available in programmed auto. For ease of access, you can assign lock to the **FUNC** button by selecting **Lock** in the **Assign FUNC** sub-menu of the shooting menu.

### Shutter-Speed Lock

If lock has been assigned to the **FUNC** button, shutter speed can be locked at the selected value by pressing the **FUNC** button (A) and rotating the main command dial (B) until the shutter-speed lock icons appear in the viewfinder and the control panel on top of the camera (C). To unlock shutter speed, press the **FUNC** button and rotate the main command dial until the lock icons disappear from the displays.

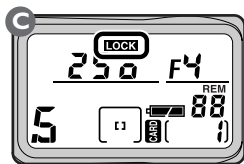
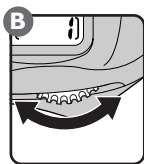
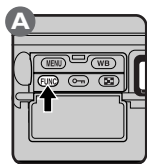

### Aperture Lock

If lock has been assigned to the **FUNC** button, aperture can be locked at the selected value by pressing the **FUNC** button (A) and rotating the sub-command dial (B) until the aperture lock icons appear in the viewfinder and the control panel on top of the camera (C). To unlock aperture, press the **FUNC** button and rotate the sub-command dial until the lock icons disappear from the displays.

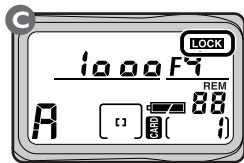
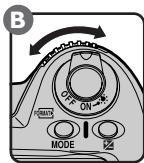
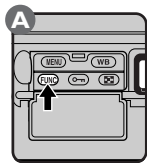

### The Command Lock Menu

Shutter-speed and aperture can also be locked from the command-lock sub-menu. In the shooting menu, highlight **Command Lock** and press the multi-selector to the right to display command-lock options. Highlight the desired option and press the multi-selector to the right to put your choice into effect and return to the shooting menu.

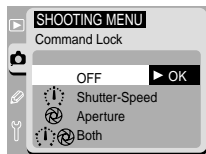

The following options are available:

Option	Description
<b>OFF</b>	Locks that apply in the current exposure mode are released.
<b>Shutter-Speed</b>	Only shutter speed is locked. This option is not available in aperture-priority auto and programmed auto exposure modes.
<b>Aperture</b>	Only aperture is locked. This option is not available in shutter-priority auto and programmed auto exposure modes.
<b>Both</b>	Both shutter speed and aperture are locked. This option is only available in manual exposure mode.



**For more information on:**

pg. 116 The **Assign FUNC** sub-menu

pg. 188 The shooting menu

# Auto-Exposure Lock

Auto-exposure lock makes it possible to use spot or center-weighted metering to measure exposure for a subject that will not be in the metering area in the final composition. With the subject positioned in the metering area, press the AE-L/AF-L button to measure exposure. Exposure will be fixed at this setting while the button is pressed, allowing you to maintain the metered value for exposure while recomposing the photograph.

To use auto-exposure lock:

**1** Press the metering selector lock release (1) and rotate the metering selector (2) to select center-weighted or spot metering. Matrix metering, which measures exposure for the entire frame, will not produce the desired results when used with auto-exposure lock.

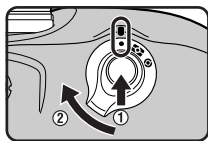

**2** After positioning the subject in the focus area (select the center focus area when using center-weighted metering), press the shutter-release button halfway and confirm that the in-focus indicator (●) appears in the viewfinder (A). Keeping the shutter-release button pressed halfway, press and hold the AE-L/AF-L button (B).

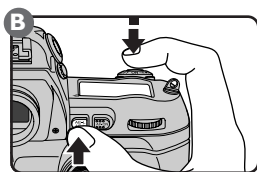
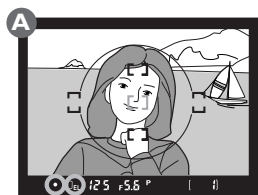

When spot metering is in effect, the camera measures exposure in the selected focus area (or in the center focus area when a non-CPU lens is in place or closest subject priority is in effect). When center-weighted metering is selected, the camera measures lighting conditions in the entire frame but assigns the greatest weight to an 8-mm circle in the center of the viewfinder.

Exposure will remain locked while the AE-L/AF-L button is pressed. In single-servo or continuous-servo autofocus, both focus and exposure will be locked while the AE-L/AF-L button is pressed. While auto-exposure lock is in effect, an **EL** indicator will be displayed in the viewfinder:

- 3 With the AE-L/AF-L button held down, recompose your photograph (A) and shoot (B).

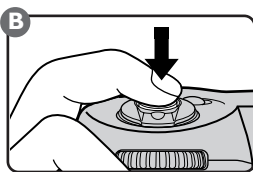
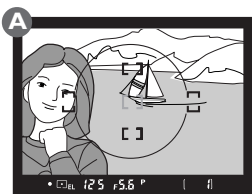

### Adjusting Shutter Speed and Aperture

While auto-exposure lock is in effect, you can:

Exposure mode	Operation
Programmed auto	Choose a new combination of aperture and shutter speed using flexible program (📖 pg. 84)
Shutter-priority auto	Adjust shutter speed
Aperture-priority auto	Adjust aperture

These operations will not affect the metered value for exposure. The adjusted values will be displayed in the viewfinder and the control panel on top of the camera.

Metering can not be adjusted while auto-exposure lock is in effect. Any changes to metering will only take effect after the AE-L/AF-L button is released.



### 7—AE Lock (📖 pg. 164)

This setting can be used to assign auto-exposure lock to the shutter-release button.



### 14—Center Weight Area (📖 pg. 168)

This option is used to set the size of the area assigned the greatest weight in center-weighted metering to 6 mm (0.24"), 10 mm (0.39"), 13 mm (0.51"), or to the average of the entire frame.



### 21—AE-L/AF-L Button (📖 pg. 172)

Using this option, the AE-L/AF-L button can be set to lock focus and exposure, focus only, or exposure only, or to lock exposure when pressed and maintain this setting until pressed a second time.

# Exposure Compensation

Exposure compensation is used to deliberately modify exposure from the optimum value selected by the camera. It can be used when, for example, photographing subjects containing areas of high contrast at a variety of different exposures. Exposure compensation is at its best when combined with spot or center-weighted metering.

- 1 Press the  button and rotate the main command dial. Exposure compensation can be set to any value between +5 EV and -5 EV in increments of  $\frac{1}{3}$  EV ( $\frac{1}{3}$  step). As a rule of thumb, use a positive value for exposure compensation when the background is brighter than the main subject, a negative value when the background is darker than the main subject.

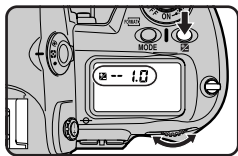

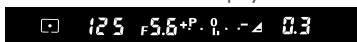

Viewfinder display



-0.3 EV



+2 EV

At values other than  $\pm 0$ , a  indicator appears in the viewfinder and in the control panel on top of the camera and the "0" at the center of the electronic analog exposure display will blink. The current exposure-compensation setting can be confirmed at any time by pressing the  button, or by viewing the electronic analog exposure display

**2** Frame the photograph, focus, and shoot.

Normal exposure can be restored by setting exposure compensation to zero, or by performing a two-button reset. Exposure compensation is not reset when the camera is turned off.



### **2—EV Steps for Exposure Control (👁️ pg. 161)**

This setting can be used to set the increments for exposure compensation to  $\frac{1}{2}$  or 1 step.



### **13—Easy Exposure Compensation (👁️ pg. 167)**

This setting can be used to allow exposure to be set with the command dials alone.



# Auto Bracketing

When auto bracketing is in effect, the camera varies exposure automatically with each shot (to a maximum of three shots), raising or lowering exposure by a pre-determined amount (up to  $\pm 2$  EV) relative to the value selected by the camera or chosen using exposure compensation. Auto bracketing is available in all exposure modes.

1 Pressing the BKT button (A), rotate the main command dial until **BKT** is displayed in the control panel on top of the camera (B).

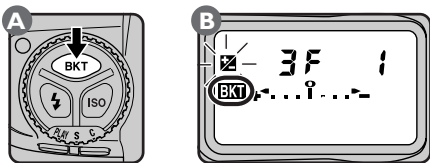

2 Pressing the BKT button (A), rotate the sub-command dial (B) to choose a bracketing program (C).

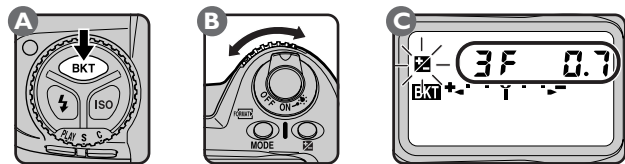

The exposure settings affected by auto bracketing depend on the exposure mode.

Exposure mode	Camera sets exposure by varying
Programmed auto	Shutter speed and aperture
Shutter-priority auto	Aperture
Aperture-priority auto	Shutter speed
Manual	Shutter speed



2—EV Steps for Exposure Control (pg. 161)

This setting controls the size of the increments for auto bracketing.



11—AE/Flash Bracketing (pg. 166)

If a Speedlight is used in combination with auto bracketing, both the flash level (TTL level for the main subject) and exposure will vary with each shot. Using Custom Setting 11, you can program the camera so that bracketing affects only the flash level or only the exposure value.

The bracketing programs available depend on the size of the EV steps selected using Custom Setting 2.

#### Custom Setting 2 Set to 1/3 Step

Option	Exposure display	Bracketing order
-2F1.0	+ . . .   . . . ▶	0 / -1.0
-2F0.7	+ · ·   · · ▶	0 / -0.7
-2F0.3	+ · ·   · · ▶	0 / -0.3
+2F1.0	+▲ . . .   . . . -	0 / +1.0
+2F0.7	+▲ · ·   · · -	0 / +0.7
+2F0.3	+▲ · ·   · · -	0 / +0.3
-3F1.0	+ . . .   . . . ▶	-1.0 / -2.0 / 0
-3F0.7	+ · ·   · · ▶	-0.7 / -1.3 / 0
-3F0.3	+ · ·   · · ▶	-0.3 / -0.7 / 0
+3F1.0	+▲ . . .   . . . -	+1.0 / 0 / +2.0
+3F0.7	+▲ · ·   · · -	+0.7 / 0 / +1.3
+3F0.3	+▲ · ·   · · -	+0.3 / 0 / +0.7
3F1.0	+▲ . . .   . . . ▶	0 / -1.0 / +1.0
3F0.7	+▲ · ·   · · ▶	0 / -0.7 / +0.7
3F0.3	+▲ · ·   · · ▶	0 / -0.3 / +0.3

#### Custom Setting 2 Set to 1/2 Step

Option	Exposure display	Bracketing order
-2F1.0	+ . . .   . . . ▶	0 / -1.0
-2F0.5	+ . . .   . . . ▶	0 / -0.5
+2F1.0	+▲ . . .   . . . -	0 / +1.0
+2F0.5	+▲ . . .   . . . -	0 / +0.5
-3F1.0	+ . . .   . . . ▶	-1.0 / -2.0 / 0
-3F0.5	+ . . .   . . . ▶	-0.5 / -1.0 / 0
+3F1.0	+▲ . . .   . . . -	+1.0 / 0 / +2.0
+3F0.5	+▲ . . .   . . . -	+0.5 / 0 / +1.0
3F1.0	+▲ . . .   . . . ▶	0 / -1.0 / +1.0
3F0.5	+▲ . . .   . . . ▶	0 / -0.5 / +0.5

#### Custom Setting 2 Set to 1 Step

Option	Exposure display	Bracketing order
-2F1.0	+ . . .   . . . ▶	0 / -1.0
+2F1.0	+▲ . . .   . . . -	0 / +1.0
-3F1.0	+ . . .   . . . ▶	-1.0 / -2.0 / 0
+3F1.0	+▲ . . .   . . . -	+1.0 / 0 / +2.0
3F1.0	+▲ . . .   . . . ▶	0 / -1.0 / +1.0

- 3 To take the first photograph in the series, compose the photograph, focus, and shoot. If the shutter-release button is held down with the mode dial set to C (continuous mode), shooting will end automatically once the number of shots specified in the bracketing program (two or three) has been taken. In single-frame and self-timer modes, one photograph is taken each time the shutter-release button is fully pressed. To cancel bracketing before all photographs in the series have been taken, press the BKT button and rotate the main command dial until **BKT** is no longer displayed in the control panel on top of the camera. The program selected at the time auto bracketing was cancelled will be restored the next time auto bracketing is used.



During shooting, the camera shows the modified values for shutter speed and aperture.

Bracketing can be combined with exposure compensation to produce compensation values greater than +2.0 or less than -2.0 while bracketing is in effect.

If the camera is turned off before all photographs in the sequence have been taken, bracketing will resume from the next shot in the sequence when the camera is turned on. If the memory card fills up before all photographs in the sequence have been taken, shooting can be resumed from the next shot in the sequence after images have been deleted or a new memory card inserted.



### 3—Bracketing Order (👁️ pg. 162)

This setting can be used to change the bracketing order so that bracketing proceeds from underexposure to overexposure.



### **For more information on:**

pg. 103 Using the self-timer

pg. 98 Exposure compensation

## Self-Timer Mode

The self-timer can be used to reduce camera shake or for self-portraits. The camera should be placed on a stable, level surface; use of a tripod is recommended.

To take photographs using the self-timer:

- 1 Press the mode dial lock release (1) and rotate the mode dial (2) to select  (self-timer mode).

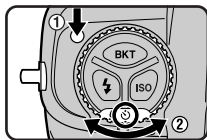

- 2 Frame the photograph and focus. When using single-servo autofocus, confirm that the in-focus indicator (●) is displayed in the viewfinder, as otherwise the shutter can not be released. If the exposure mode is not set to manual (M), close the shutter that covers the viewfinder eyepiece (A) to prevent light entering through the eyepiece from affecting auto-exposure. After focusing the camera, press the shutter-release button all the way down to start the self-timer (B). The self-timer lamp on the front of the camera will start to blink (C), stopping approximately two seconds before the shutter is released automatically to take the photograph.

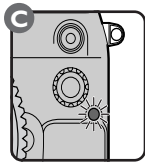
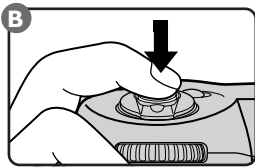
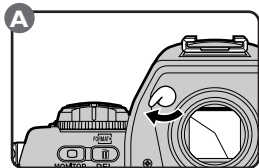

Do not stand in front of the lens to start the timer when autofocus is in effect.

If the shutter speed is set to **bulb** in self-timer mode, shutter speed will be set to approximately  $\frac{1}{4}$  s.



To turn the self-timer off before a photograph is taken, turn the mode dial to another setting.



### 16—Self-timer Delay pg. 169

Self-timer delay can be set to 10 (the default setting), 2, 5, or 20 seconds using this option.

## Diopter Adjustment

The viewfinder is equipped with diopter adjustment to accommodate individual differences in vision.

To adjust viewfinder diopter, pull the diopter knob out and rotate it until the focus brackets in the viewfinder are in sharp focus. Diopter can be adjusted in the range between  $-3\text{ m}^{-1}$  and  $+1\text{ m}^{-1}$ . Corrective lenses (available separately) allow diopters of  $-3\text{ m}^{-1}$  to  $+2\text{ m}^{-1}$ . Once you have adjusted diopter to your satisfaction, push the diopter knob back into the body of the camera.

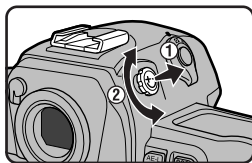

When operating the diopter knob, be careful to avoid injuring your eye with your finger or fingernail.



**For more information on:**

pg. 198 Optional accessories

Using the LCD illuminators (control panel backlights), you can illuminate the control panels to view camera settings in the dark.

To turn the illuminators on, rotate the power switch to the  position. The illuminators will remain on while the switch is held in this position. After the switch is released, the illuminators will remain on while exposure indicators are displayed or until the shutter is released.

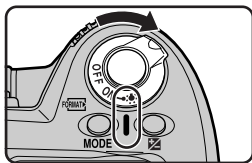

## Depth-of-Field Preview

To check depth of field for the current aperture setting, press and hold the depth-of-field preview button.

The lens will be stopped down to the aperture selected by the camera in programmed auto or shutter-priority auto exposure modes, or to the value selected by the user in aperture-priority or manual modes. The view through the viewfinder provides an approximation of the depth of field that can be obtained at the current aperture setting.

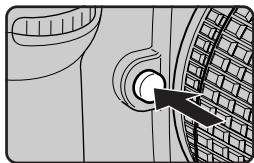

## Focal Plane Position

The position of the focal plane inside the camera is indicated by a mark on the camera body.

The distance between the camera and the subject should be measured from this mark whenever distance is measured manually. The distance between the lens mounting flange and the focal plane is 46.5 mm (1.83").

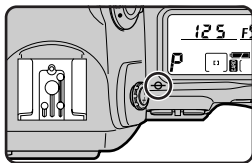



To use TTL flash control, connect an SB-28DX or SB-50DX Speedlight to the camera and set the flash to D-TTL auto-flash mode. Depending on the type of lens used, one or more of the following TTL flash modes will be available. TTL flash control is available only with the SB-28DX and the SB-50DX.

### ***3D Multi-Sensor Balanced Fill-Flash for Digital SLR***

#### ***Multi-Sensor Balanced Fill-Flash for Digital SLR***

This mode is available when a CPU Nikkor lens is attached. Based on information from the matrix metering system, flash output is adjusted to maintain a balance between the main subject and ambient background lighting. When the shutter-release button is pressed, the Speedlight emits a series of nearly invisible preflashes (monitor preflashes) immediately before the shutter opens. The monitor preflashes are reflected from objects in all areas of the frame and picked up by the camera's TTL multi sensor; where they are analyzed instantaneously in combination with information on the current sensitivity (ISO equivalency) setting, aperture, lens focal length, and exposure compensation value. The results of this analysis are used to balance flash output with ambient light. When a type G or D lens is used, distance information is included in the calculation for still more precise flash control (3D multi-sensor balanced fill flash).

#### ***Center-Weighted Fill-Flash for Digital SLR***

This mode is used with non-CPU lenses. When a non-CPU lens is attached, the camera automatically chooses center-weighted metering, allowing flash output to be roughly balanced with ambient lighting for the main subject and background. The camera may be unable to adjust exposure correctly if the frame includes a highly reflective object, or if the background is non-reflective. Standard TTL flash control is recommended in such cases. Standard TTL flash control is activated automatically when spot metering is selected.

#### ***Standard TTL Flash for Digital SLR***

Standard TTL flash control is available with lenses of all types. Standard TTL flash control does not take the brightness of the background into account, instead adjusting flash output to ensure that the main subject is correctly exposed. This makes it suited to photographs in which the main subject is emphasized at the expense of other details, or when exposure compensation is used. This mode is also activated automatically when spot metering is selected.

Your Nikon digital camera is equipped with an accessory shoe for attaching Speedlights directly to the camera and a sync terminal that allows Speedlights to be connected via a sync cable. When a Speedlight is connected, the flash-ready indicator in the viewfinder shows whether the flash is fully charged and ready for use.

## Accessory Shoe

SB-28DX, SB-50DX, SB-28, SB-27, SB-26, SB-25, SB-24, SB-23, SB-22s, SB-29 and so on. Speedlights can be attached directly to the accessory shoe without the need for a sync cable. The accessory shoe is equipped with a safety lock that keeps Speedlights equipped with a locking pin (the SB-28DX, SB-28, SB-27, SB-26, SB-25, SB-22s, and SB-29) in place.

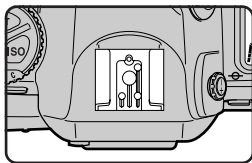

## Sync Terminal

A sync cable can be connected to the sync terminal as required. Do not attach another Speedlight via a sync cable when performing rear-curtain sync flash photography with an SB-28DX, SB-50DX, SB-28, SB-27, SB-26, SB-25, SB-24, SB-23, SB-22s, or SB-29 Speedlight attached to the accessory shoe.

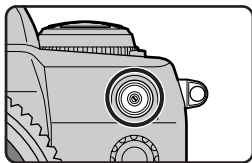

## Flash-Ready Indicator



When an SB-28DX, SB-50DX, SB-28, SB-27, SB-26, SB-25, SB-24, SB-23, SB-22s, or SB-29 Speedlight is connected, the flash-ready indicator will light to show that the flash is fully charged and ready for use. If the indicator blinks for approximately three seconds immediately after a photograph is taken in D-TTL or non-TTL auto flash mode, the flash has fired at full output and the photograph may not have been correctly exposed. Check the results in the monitor. If the photograph is underexposed, adjust the distance to the subject, aperture, shutter speed, or flash range and try again.

## Flash Sync Modes

Five sync modes are available. To set the flash sync mode, press the flash mode button (A) while turning the main command dial (B).

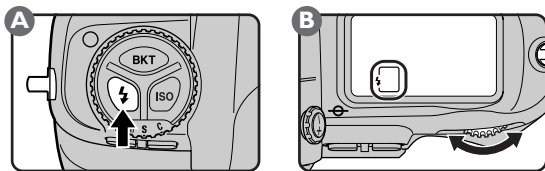

The camera will cycle through the available flash-sync modes in the order shown below.

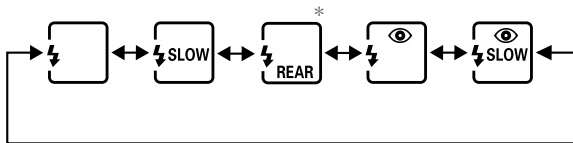

\* In programmed auto and aperture-priority auto modes, the mode icon shown at right will be displayed when the flash mode button is released.







When red-eye reduction is used, there is a one-second delay between your fully pressing the shutter-release button and the shutter being released. Be careful not to move the camera or to let your subject move during this time. Red-eye reduction works best when your subject is well within the range of the flash and is fully turned to face the camera.

To prevent blurring caused by camera shake, use of a tripod is recommended with slow sync or red-eye reduction with slow sync.

Rear-curtain sync can not be used with a studio flash system.

The following flash-sync modes are available:

Flash sync mode	Description
 Front-curtain sync	<p>This mode is recommended in most situations. When using the SB-26, SB-25, or SB-24, set the sync mode selector on the Speedlight to NORMAL.</p>
 Slow sync	<p>The flash is combined with shutter speeds as slow as 30 s, taking ambient lighting into account to bring out background details. In programmed auto and aperture-priority auto exposure modes, the shutter speed chosen automatically by the camera is usually <math>\frac{1}{500}</math>–<math>\frac{1}{60}</math> s.</p>
 Rear-curtain sync	<p>Use this mode to suggest motion by creating a stream of light that appears to follow moving objects. When this mode is combined with programmed auto or aperture-priority auto, shutter speed is slowed to achieve the same effect as slow sync. When using the SB-26, SB-25, or SB-24, set the Speedlight sync mode selector to REAR.</p>
 Red-eye reduction	<p>In this mode (available only with SB-28DX, SB-28, SB-27, and SB-26), a red-eye reduction pre-flash lights for approximately one second before the main flash, causing the pupils in your subjects' eyes to contract and reducing the "red-eye" effect a flash can sometimes cause.</p>
 Red-eye reduction with slow sync	<p>This mode combines red-eye reduction with slow sync (available only with SB-28DX, SB-28, SB-27, and SB-26). Set the exposure mode to programmed auto or aperture-priority auto.</p>

## Compatible Speedlights

Your Nikon digital camera can be used with the optional Speedlights shown below.

Speedlight	Lens	Flash mode		
		TTL <sup>1</sup>		A
		Balanced fill-flash	Standard TTL <sup>2</sup>	Non-TTL auto
SB-28 DX SB-50 DX <sup>13</sup> (cordless)	Type G or D Nikkor <sup>3</sup>	✓ <sup>4</sup>	✓	✓ <sup>5</sup>
	Other CPU Nikkor <sup>6</sup>	✓ <sup>7</sup>	✓	✓ <sup>5</sup>
	Other Nikkor lens	✓ <sup>8</sup>	✓	✓ <sup>9, 13</sup>
SB-28 (cordless)	All types	—	—	✓
SB-27 (cordless)	All types	—	—	✓
SB-26 <sup>10</sup> (cordless)	All types	—	—	✓
SB-25 (cordless)	All types	—	—	✓
SB-24 (cordless)	All types	—	—	✓
SB-23/SB-21B <sup>11</sup> / SB-29 (cordless)	All types	—	—	—
SB-22S/SB-22/ SB-20/SB-16B/ SB-15 (cordless)	All types	—	—	✓
SB-11 <sup>12</sup> /SB-14	All types	—	—	✓

1 Can only be used when an SB-28DX or SB-50DX is attached. When other Speedlights are attached and set to TTL, the shutter-release button will lock and no photographs can be taken.

2 When spot metering is used, this setting is treated as “standard D-TTL flash control” (see above).

3 IX-Nikkor excluded.



4 3D multi-sensor balanced fill-flash for the D1 series.

5 Auto aperture (AA).

6 Excluding AF Nikkor lenses for the F3AF.

7 Multi-sensor balanced fill-flash for the D1 series.

8 Center-weighted fill-flash for the D1 series.

Flash mode				
M			REAR	
Manual	FP high-speed sync	Repeating flash	Rear-curtain sync	Red-eye reduction
✓	✓ <sup>13</sup>	✓ <sup>13</sup>	✓	✓ <sup>13</sup>
✓	✓ <sup>13</sup>	✓ <sup>13</sup>	✓	✓ <sup>13</sup>
✓	✓ <sup>13</sup>	✓ <sup>13</sup>	✓	✓ <sup>13</sup>
✓	✓	✓	✓	✓
✓	—	—	✓	✓
✓	✓	✓	✓	✓
✓	✓	✓	✓	—
✓	—	✓	✓	—
✓	—	✓	✓	—
✓	—	—	✓	—
✓	—	—	✓	—

9 Non-TTL auto flash (A).

- 10 The SB-26 can be set to slave mode for wireless slave flash photography. When the wireless slave selector is set to D, shutter speed will be set to a value under  $\frac{1}{200}$  sec.
- 11 Autofocus can only be used with the SB-21B or SB-29 when a AF-Micro lens (60 mm, 105 mm, 200 mm) is attached.
- 12 When using the SB-11 or SB-14 in A or M mode, connect the SC-13 using the SU-2. While the SB-11 and SB-14 can be connected using the SC-11 or SC-15, the flash-ready indicator will not appear in the viewfinder display and shutter speed will not be adjusted automatically.
- 13 The SB-50DX Speedlight, (available separately,) can not be used with Non TTL auto, FP high-speed sync, Repeating flash, or Red-eye reduction.

## Compatible Speedlights (continued)



Refer to your Speedlight manual for detailed instructions. In the table of different camera types given in the SB-28DX manual, your Nikon digital camera is classified as type A.

The shutter will synchronize with the flash when set to speeds of  $1/500$  sec. or slower. When using the Medical Nikkor 120 mm f/4 lens, set the shutter speed to  $1/125$  sec. or slower.

If the flash-ready indicator blinks for about three seconds after a photograph is taken with the SB-28DX or SB-50DX set to D-TTL, the photograph may be underexposed. Check the photograph in the monitor. If it is underexposed, adjust the focus distance, aperture, or flash range and try again.

The underexposure warning may not be displayed when Speedlights other than the SB-28DX or SB-50DX are used with a shutter speed of  $1/500$  s. Should you find that images are underexposed even when no warning has appeared in the viewfinder, set the shutter speed to  $1/250$  s and try again.

EV steps for exposure control are set to  $1/3$  increments on the Speedlight exposure display. Therefore when the display on the camera body is set to  $1/2$  increments (using Custom Setting 20), the Speedlight exposure display will not show the correct ISO value. This does not affect the actual exposure value which will be set as displayed on the camera body.

Sensitivity settings available for D-TTL flash photography are ISO 200, 250, 320, 400, 500, 640, 800, 1000, 1250 and 1600 equivalent. If Sensitivity Boost (Custom Setting 31) is used, the flash may not produce appropriate lighting, depending on the aperture or distance to the subject.

In the case of Speedlights equipped with an AF-Assist Illuminator, the illuminator will only light when the center focus area is used.

When the exposure mode is set to programmed auto, the maximum aperture varies with sensitivity, as shown below:

<b>Sensitivity (ISO equivalent)</b>	200	250	320	400	500	640
<b>Maximum aperture</b>	4.8	5	5.3	5.6	6	6.3
<b>Sensitivity (ISO equivalent)</b>	800	1,000	1250	1600		
<b>Maximum aperture</b>	6.7	7.1	7.6	8		

For each increase in sensitivity, aperture is stopped down by half a step. If the lens has a smaller maximum aperture than that given above, the maximum aperture will be the maximum aperture for the lens.

When flash exposure compensation is used,  appears in the viewfinder display, but the amount of compensation is not displayed.

If the Speedlight is set at a distance from the camera using the SC-17 sync cord, correct exposure may not be achieved at D-TTL settings other than standard D-TTL. We recommend that you use standard D-TTL. When using standard D-TTL, take a test shot and view the results in the monitor.

When using D-TTL flash control, use the flash panel provided with your Speedlight. Do not use another type of flash panel, such as a diffusion panel, as this may introduce error into camera-internal calculations, resulting in inappropriate flash exposure.

When the flash sync mode is set to slow sync or slow sync with red-eye reduction, select programmed auto or aperture-priority auto exposure.

The shutter speeds and apertures that can be used with the SB-28DX and SB-50DX are shown below.

Exposure mode	Shutter speed	Aperture	
Programmed auto	Set automatically by camera*	Set automatically by camera	pg. 84
Shutter-priority auto	$1/500 - 30 \text{ s}^{**}$		pg. 86
Aperture-priority auto	Set automatically by camera*	Value chosen by user	pg. 88
Manual	$1/500 - 30 \text{ s}^{**}$ , <b>bulb</b>		pg. 90

\* Shutter speeds are set automatically in the range  $1/500 - 1/60 \text{ s}$ , or  $1/500 - 30 \text{ s}$  at a flash sync mode setting of slow sync.

\*\* If a shutter speed faster than  $1/500 \text{ s}$  is chosen, the camera will automatically lower the shutter speed to  $1/500 \text{ s}$  when the Speedlight is turned on.

TTL can not be used for multi-flash photography.



Use Nikon Speedlights only. Using another make of flash could damage the internal circuitry of the camera or flash. Before using a Nikon Speedlight not included in the list of compatible Speedlights, contact a Nikon-authorized service representative for more information.





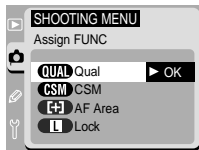

## The FUNC Button

By assigning image quality, custom settings, command lock, or AF-area mode to the **FUNC** button, you can adjust the selected setting using the command dial while confirming changes to settings in the rear control panel.

To assign a new function to the **FUNC** button, highlight **Assign FUNC** in the shooting menu and press the multi-selector to the right to display the controls menu. Highlight the desired setting and press the multi-selector to the right to return to the shooting menu.



The following options are available:

Option	Description	
 <b>QUAL</b> Qual	Image quality can be set using the <b>FUNC</b> button and the command dials.	pg. 56
 <b>CSM</b> CSM	Custom settings can be selected using the <b>FUNC</b> button and the command dials.	pg. 156
 <b>AF Area</b>	AF-area mode can be selected using the <b>FUNC</b> button.	pg. 74
 <b>Lock</b>	The <b>FUNC</b> can be used with the command dials to lock shutter speed and/or aperture.	pg. 94



**For more information on:**

pg. 188 The shooting menu

When sequential file numbering is in effect, file and folder numbers will continue to be assigned sequentially in ascending order from the last number used whenever you create a new folder, insert a new memory card in the camera, or format the existing memory card. For more information on sequential file numbering, see Custom Setting 29, File Number Sequence (👁 pg. 179).

To choose a file-numbering option, highlight **File No. Seq.** in the shooting menu and press the multi selector to the right. The menu shown at right will be displayed. Highlight the desired setting and press the multi selector to the right to return to the shooting menu.



The following options are available:

Option	Description
<b>OFF</b>	Continuous sequential file numbering off.
<b>ON</b>	Continuous sequential file numbering on.
<b>Reset</b>	Sequential numbering begins again from the lowest number available in the current folder.

# Taking Photographs with GPS

The camera is equipped with an RS-232C serial interface that can be used for connection to a Global Positioning System (GPS) device, allowing information about the camera's current position to be recorded when photographs are taken.

The **GPS Input** sub-menu can be used to ready the camera's RS-232C interface for connection to a GPS device. In the setup menu, highlight **GPS Input** and press the multi-selector to the right. The menu shown at right will be displayed. Highlight the desired option and press the multi-selector to the right to return to the setup menu.

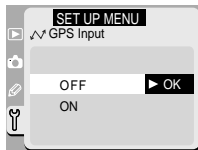

The **GPS Input** menu contains the following options:

Option	Description
OFF	Disables the serial port connection.
ON	Configures the serial interface for connection to a GPS device.

Data transfer between the camera and GPS device will not take place in playback mode, even when GPS is selected in the GPS Input menu.

When communication is established with the GPS device, the letter "D" will appear in the control panel on top of the camera, remaining until the exposure indicators in the control panel turn off automatically or the camera is turned off. Once the letter "D" is displayed, information on the camera's current position received while the camera is in communication with the GPS device will be stored with the image data for each photograph, even if the communication between the camera and the device is later interrupted.

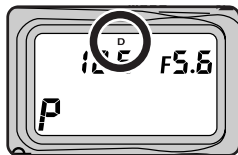

GPS data will be included in the photo information for any photographs taken while the letter "D" is displayed in the control panel.

When using a GPS device to record the camera's position, check to be sure that the letter "D" is displayed in the control panel on top of the camera before taking any photographs. Particularly immediately after the GPS device is turned on, the position will not be recorded if you release the shutter in one motion, without first pressing the shutter-release button halfway and waiting for the camera to focus.

For more information on using and connecting GPS devices, see the manual provided with the device.

## ✓ Connecting a GPS Device

When connecting a GPS device via a serial cable, be sure that the cable is connected to the camera's RS-232C serial interface terminal and that a 2.5-mm stereo mini-jack is used for connection to the camera. Using another type of connector or inserting the connector into another terminal could damage the camera or cable.

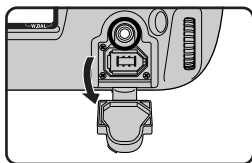

## ✎ Compatible GPS Devices

GARMIN or MAGELLAN GPS devices compatible with the NMEA0183 ver: 2.01 protocol can be used with you camera. (NMEA=National Marine Electronics Association)  
Operation has been confirmed with the following GPS devices:

- GARMIN GPS III
- MAGELLAN COLORTRAK

Because cables for connecting GPS devices to the camera are not available from Nikon, the user must supply a suitable cable. The RS-232 terminal on the camera is designed to fit a 2.5 mm stereo mini-jack. To connect the camera and the GPS device, a GND line and Data-Out line (Data-Out here refers to the GPS device) are required. The GND line from the GPS device must be connected to the GND line from the 2.5 mm stereo mini-jack. The Data-Out line from the GPS device must be connected to the Data-In line from the 2.5 mm stereo mini-jack.

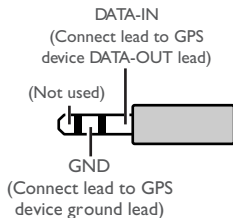

## 👁 For more information on:

pg. 190 The setup menu

pg. 124 Photo information

# Playback Options

Photographs can be played back by turning the mode dial to PLAY (playback mode), by pressing the monitor button in single-frame, continuous, self-timer or PC mode (quick review), or using “image review” to view photographs in the monitor automatically as they are recorded to the memory card.

## Playback Mode

Playback mode is used only for playing images back, not for taking photographs. Playback mode can be selected by pressing the mode dial lock release and rotating the mode dial to PLAY.

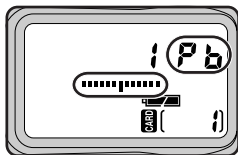
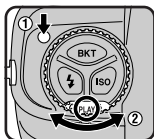

## Quick Review

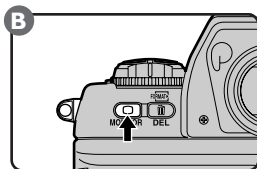
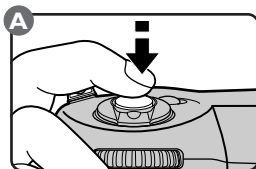

In single-frame, continuous, self-timer or PC mode, images stored on the memory card can be viewed at the touch of a button, without setting the mode dial to PLAY. Press the  button (B) to view the last photograph taken (if the camera is in sleep mode, with no aperture or shutter-speed indicators displayed, first press the shutter release button halfway (A) to reactivate the camera).



If the memory card is empty when playback or quick review mode is selected, the message “No images in current folder” will be displayed.

## Image Review

In single-frame, continuous, self-timer, and PC modes, photographs can be viewed as they are recorded to the memory card. Photographs will not be displayed in the monitor in PC mode when the camera is connected to a computer running Nikon Capture 2.

- 1 Select **On** in the **Image Review** menu (Custom Setting 1;  pg. 161).
- 2 Take a photograph with the mode dial set to S (single-frame), C (continuous),  (self-timer) or PC.

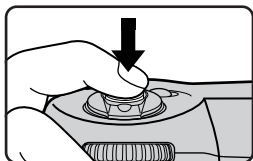
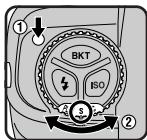

While the photograph is recorded to the memory card, the monitor will turn on automatically and the photograph you have just taken will be displayed. In single-frame and self-timer modes, one photograph will be displayed each time the shutter is released. In continuous mode, the photographs in each sequence will be displayed in order when shooting is complete. Review begins when you release the shutter button.

If additional photographs are taken while images are on display, preview will be interrupted.



In playback and quick review modes, or when using image review in continuous mode, photographs can be displayed one at a time or in “contact sheets” of four or nine thumbnail images (see “Choosing the Number of Images Displayed,” below).

The playback operations described below can be used in playback, quick-review, and record-and-review modes.

## Choosing the Number of Images Displayed

During playback, images can be viewed one at a time or in “contact sheets” of four or nine thumbnail images. To choose the number of images displayed, press the  button (A) while rotating the main command dial (B).

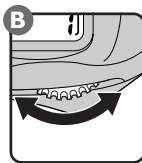
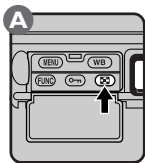

Single frame

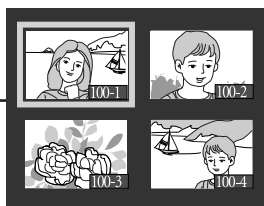

Four thumbnails

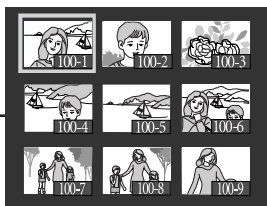

Nine thumbnails



If card contains fewer than the selected number of images in thumbnail playback, thumbnails will be displayed at the top left corner of the monitor.

The setting chosen applies in playback, quick-review, and, when shooting in continuous mode, record-and-review modes.

### **Turning the Monitor Off**

The monitor turns off if:

- No operations are performed in the time specified in Custom Setting 18 (Monitor Off Delay).
- The  button is pressed.
- The shutter-release button is pressed halfway or a photograph is taken in quick review or record-and-review. Note that if additional photographs are taken while images are on display in record-and-review, preview will be interrupted.



***For more information on:***



### Single-Frame Playback

Unlock the multi selector and press it up or down to view additional images.

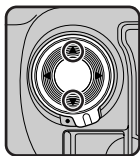

In playback and quick-review modes, the first and last images in memory are linked. Pressing the multi selector down when the most recent image is displayed will take you to the oldest photograph in memory. Pressing the multi selector up when the oldest photograph is displayed will take you to the most recent photograph.

To view information on the current photograph, press the multi selector to the right or left to cycle through photo information as shown below.

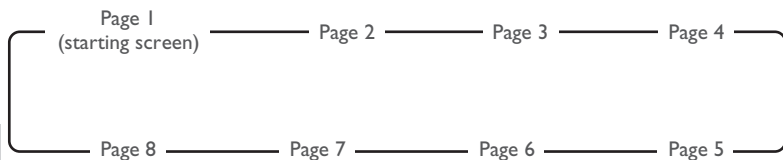

Page 6 (image histogram) and Page 7 (image highlights) are only shown if the appropriate option has been selected in the **Display Mode** sub-menu of the playback menu. Page 5 is only shown if a GPS unit was connected when the photograph was taken. Depending on the lens used, some information may not be displayed.



**For more information on:**

pg. 142 The **Display Mode** sub-menu

pg. 118 Connecting a GPS device

The photo information display contains the following items:

### Page 1



- 1 Protect status
- 2 Folder number/frame number

### Page 2

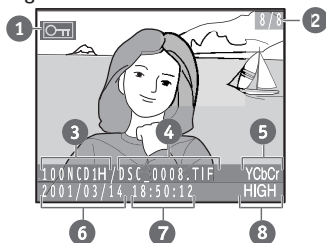

- 1 Protect status
- 2 Frame number/total number of frames
- 3 Folder name
- 4 File name
- 5 File format
- 6 Date of recording
- 7 Time of recording
- 8 Image quality

### Page 3

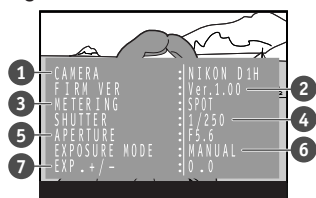

- 1 Camera type
- 2 Camera firmware version
- 3 Metering method
- 4 Shutter speed
- 5 Aperture
- 6 Exposure mode
- 7 Exposure compensation

### Page 4

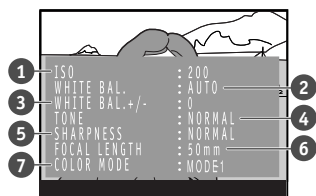

- 1 Sensitivity (ISO equivalency)
- 2 White balance
- 3 White balance adjustment
- 4 Tone compensation
- 5 Sharpening
- 6 Focal length
- 7 Color mode

Page 5 (GPS Data)\*



Page 6 (Histogram)\*

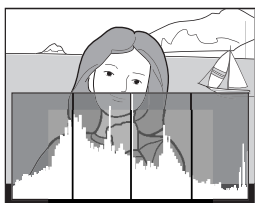

Page 7 (Image Highlights)\*



Page 8 (Image Only)



- 1 Latitude
- 2 Longitude
- 3 Altitude

\* Only shown for images taken with a GPS unit attached.

The histogram takes the form of a bar graph, with pixel brightness on the horizontal axis and the vertical axis showing the number of pixels of each brightness in the image.

\* Only shown when histogram display is selected in the playback **Display Mode** menu.

The brightest portions of the image (image highlights) blinking on and off.

\* Only shown when highlight display is selected in the playback **Display Mode** menu.

No photo information is displayed.

## Thumbnail Playback

When thumbnails are displayed, the desired frame can be highlighted using the multi selector:

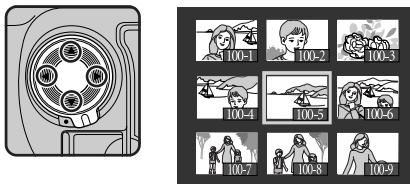

To scroll through thumbnails a page at a time, press the  button while rotating the sub-command dial.

### Zoom

To zoom in on the image currently displayed in single-frame playback, or on the image currently selected in the thumbnail display, press the **FUNC** button.

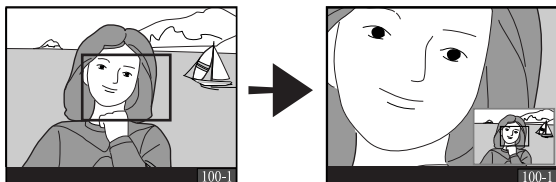
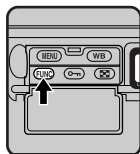

The center of the image will be enlarged to fill the monitor. To view other areas of the photograph, press the multi selector. To cancel zoom and return to normal playback, press the **FUNC** button.

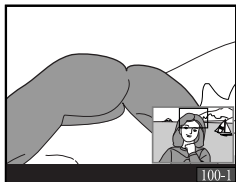
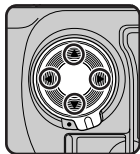

For approximately two seconds after you press the **FUNC** button to zoom in on the image, or after you press the multi selector to scroll the image, a thumbnail showing your current position in the image will appear in the bottom right corner of the display.





### RAW Images

Playback zoom is not available for RAW images taken with the D1x.

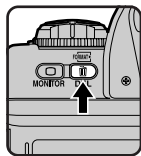

## Deleting Individual Photographs

The photograph on display in single-frame playback, or the image currently selected in thumbnail playback, can be deleted using the  button (to delete several images at once, use the **Delete** option in the playback menu). Once deleted, images can not be recovered.

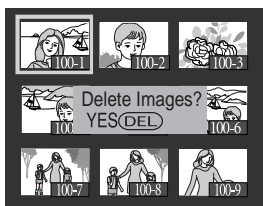
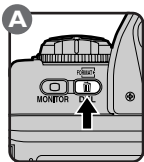

- 1 Display the image you want to delete (single-frame playback), or highlight the image in the thumbnail display (thumbnail playback).
- 2 Press the  button (A). A confirmation dialog will be displayed (B).



- 3 Press the  button a second time to delete the photograph and return to playback or review mode. To exit without deleting the photograph, press the  button.

### Deleting Photographs: The Delete Menu

The **Delete** option in the playback menu can be used to delete selected photographs or all photographs on the memory card, and to cancel print-order files created with the **Print Set** option.

To display the **Delete** sub-menu, highlight **Delete** in the playback menu and press the multi selector to the right. Highlight the desired option and press the multi selector to the right to put your choice into effect.

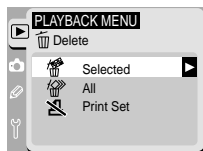

The **Delete** sub-menu contains the following options:

Option	Description
<b>Selected</b>	Select the photo or photos to be deleted from a menu of thumbnail images.
<b>All</b>	Delete all images on the memory card. Images that have been hidden or protected are not affected.
<b>Print Set</b>	Cancel the print order (delete the print-order file) created with the <b>Print Set</b> option (📄 pg. 139).



Depending on the number of folders and images files on the card, it may take half an hour or more to delete all images on the card using the **All** option in the **Delete** sub-menu.

### Deleting Selected Images

Choosing **Selected** in the **Delete** sub-menu displays a menu of thumbnail images. Highlight the images to be deleted using the multi-selector. To return to the playback menu at any time without deleting images, press the **MENU** button.



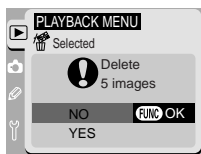

To select an image for deletion, highlight it and press the **FUNC** button. The image will be marked with a **!** icon (to deselect an image, highlight it and press the **FUNC** button a second time). Repeat until all the images you wish to delete have been selected, then press the **MENU** button. The confirmation dialog shown at right will be displayed; highlight **YES** and press the **FUNC** button to delete the selected images. To exit without deleting the images, highlight **NO** and press the **FUNC** button.







### Protecting Images from Deletion

The photograph on display in single-frame playback, or the image currently selected in thumbnail playback, can be protected from accidental deletion using the  button (to protect several images at once, use the **Protect** option in the playback menu).

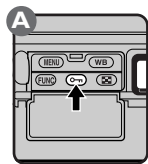
- 1 Display the image you want to protect (single-frame playback), or highlight the image in the thumbnail display (thumbnail playback).
- 2 Press the  button (A). The selected image or thumbnail will be marked by a  icon (B).



Protected status can be removed at any time to allow an image to be deleted. To remove protected status from an image, display the image (single-frame playback) or highlight it in the thumbnail display (thumbnail playback) and press the  button.



**For more information on:**

### The Protect Menu

Highlight **Protect** in the playback menu and press the multi-selector to the right. A menu of thumbnail images will be displayed, where images can be highlighted using the multi-selector. To return to the playback menu at any time without changing the protected status of images, press the **MENU** button.



To protect an image, highlight it and press the **FUNC** button. The image will be marked with a **Key** icon (to deselect an image, highlight it and press the **FUNC** button a second time). Repeat until all the images you wish to protect have been selected, then press the **FUNC** button to put any changes into effect and exit the thumbnail menu.



### File Attributes of Protected Images

Protected images have DOS-format "read-only" status.

# Playback Menu Options

In addition to the delete and protect items described above, the playback menu contains options for automated playback, hiding images during playback, creating digital “print orders,” creating new folders and specifying the folders from which images will be played back, and controlling the information included in the photo information display.

## Automated Playback: The Slide-Show Menu

The slide-show option in the playback menu allows automated sequential playback.

- 1 Highlight **Slide Show** in the playback menu and press the multi selector to the right. The menu shown at right will be displayed.

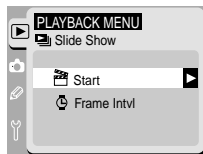

- 2 Highlight the desired option and press the multi selector to the right. The following options are available:

Option	Description
<b>Start</b>	Start the slide show.
<b>Frame Intvl</b>	Specify the length of time each image will be displayed.



- 3 To start the slide show, highlight **Start** and press the multi selector to the right. Pressing the **FUNC** button pauses the slide show and displays the menu shown in Step 4. Press the **MENU** button at any time during the slide show to return to the playback menu.

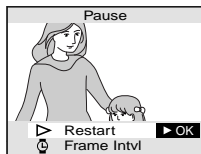

4 Once the slide show comes to an end, or after you have paused or stopped the slide show, the menu shown at right will be displayed. Using the multi selector, highlight the desired option and press the multi selector to the right to put your choice into effect. Press the multi selector to the left or press the **MENU** button to end the slide show and return to the playback menu.



The following options are available:

Option	Description
 <b>Restart</b>	Restart the slide show from the image currently displayed.
 <b>Frame Intvl</b>	Change the length of time each image is displayed.

### Changing the Display Interval

Selecting **Frame Intvl** from the slide show menu or while the slide show is paused will display the menu of interval settings shown at right. To change the length of time each image is displayed, highlight the desired option and press the multi selector to the right. The slide show will start or resume from the point it was interrupted.

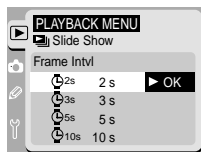





**For more information on:**

### Hiding Images During Playback: The Hide-Image Menu

When preparing a slide show or showing photographs to an audience, you may want to use the **Hide Image** option to hide some of the images on the memory card. Hidden images can only be viewed from the **Hide Image** menu, and can not be deleted using the  button or **Delete** menu.

Highlight **Hide Image** in the playback menu and press the multi selector to the right. A menu of thumbnail images will be displayed, where images can be highlighted using the multi selector: You can select any number of images to be hidden or revealed before pressing the **FUNC** button to put changes into effect and exit the thumbnail menu. To return to the playback menu at any time without changing the hidden status of images, press the **MENU** button.



To hide an image, highlight it and press the  button. The image will be marked with  and  icons (to deselect an image, highlight it and press the  button a second time). Repeat until all the images you wish to hide have been selected, then press the **FUNC** button to put any changes into effect and exit the thumbnail menu.



**For more information on:**



---

### File Attributes of Hidden Images

---

Hidden images have DOS-format “hidden” and “read-only” status.



---

### File Numbering for Hidden Images

---

Although hidden images are only displayed in the **Hide Image** menu, they are assigned file numbers, allowing the presence of hidden images to be ascertained from discontinuities in the file-numbering sequence during playback.

### Preparing Photographs for Printing: The Print-Set Menu

The Print Set option in the playback menu is used to create a digital “print order” specifying the photographs to be printed, the number of prints, and the information to be included with each print. This information is stored on the memory card in Digital Print Order Format (DPOF). The card can then be removed from the camera and inserted in a DPOF-compatible device—whether your personal photo printer or a photofinisher’s print system—and the specified images printed directly from the card. Note, however, that images taken at an image-quality setting of RAW can not be printed in this fashion.

Highlight **Print Set** in the playback menu and press the multi selector to the right. A menu of thumbnail images will be displayed, where images can be highlighted using the multi selector. To return to the playback menu at any time without changing the print order, press the **MENU** button.



To add an image to the print order, highlight it and press the **FUNC** button. The image will be marked with a  icon (to deselect an image, highlight it and press the **FUNC** button a second time). Repeat until all the images you wish to print have been selected, then press the **FUNC** button to display the menu of print options shown opposite.

#### After Creating a Print Order

- Do not use a another device, such as a computer, to delete images from the memory card after creating a print order.
- Do not change the hidden status of images currently included in the print order.

#### For more information on:

pg. 186 The playback menu

## Print Options

Once you have selected the images you want to print and pressed the **FUNC** button, the menu of options shown at right will be displayed. Highlight the desired option using the multi selector. Print options apply to all photographs in the print order:

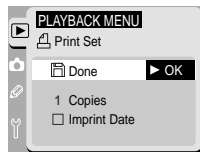

The following options are available:

Option	Description
<b>Done</b>	Complete changes to the print order and exit the print set menu.
<b>Copies</b>	Selecting this option displays the dialog shown at right. Press the multi selector up or down to select the number of copies of all images that will be printed. Press the multi selector to the right to put your selection into effect and return to the print options menu. 
<b>Imprint Date</b>	If this box is checked, the date will of recording will be printed on all the selected photographs. To select or deselect this option, highlight it and press the multi selector to the right.



## Digital Print Order Format

Digital Print Order Format (DPOF) is an industry-wide standard that allows photographs taken with a digital camera to be printed on a DPOF-compatible device, whether it be a personal photo printer or a commercial print system. Before printing, check that the device or print service supports DPOF. When taking photographs that will be printed directly from the card, we recommend that you set the color mode (Custom Setting 32) to **I (sRGB)**.



### For more information on:

pg. 181 Custom Setting 32



## Folder Options: The Folder Designate Menu

The **Folder Designate** menu is used to create new folders with user-specified folder numbers, and to select the folder or folders from which images will be played back.

In the playback menu, highlight **Folder Designate** and press the multi selector to the right. The menu shown at right will be displayed.

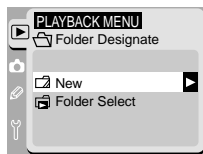

The following options are available:

Option	Description
New	When this option is selected, a dialog will appear prompting you to select a folder number. Press the multi selector up or down to select a folder number; then press the multi selector to the right to create a new folder name beginning with the specified number and ending in "NCDIH." Subsequent photographs will be stored in the new folder. Press the the <b>FUNC</b> button to put settings into effect and return to the Folder Select sub-menu.
Folder Select	Selecting this option displays the menu shown on the opposite page.



**For more information on:**

### Choosing a Folder for Playback

Selecting **Folder Select** from the Folder Designate menu displays the options shown at right. Highlight the desired item and press the multi selector to the right to put your choice into effect and return to the Folder Designate sub-menu.

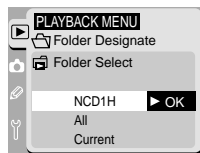

The following options are available:

Option	Description
<b>NCD1H</b>	Images in all folders created by cameras in the D1H will be visible during playback.
<b>ALL</b>	Images in all folders that conform to the Design Rule for Camera File Systems (DCF)—most digital cameras and all Nikon cameras— will be visible during playback.
<b>Current</b>	Only images in the current folder will be visible during playback.

In the Folder Select sub-menu, press the **MENU** button to return to the playback menu.



### Creating Multiple Folders

If you create several folders in succession using the **New** option and then choose **Current** from the **Folder Select** menu, only photographs in the most recently created folder will be displayed. You can not choose another folder for playback when using a camera in the D1H.

For example, suppose you create three folders in succession, I01NCD1H, I02NCD1H, and I03NCD1H. If you then choose **Current**, only photographs in I03NCD1H will be displayed. To view photographs in the other folders, you would need to choose **NCD1H** or **ALL** in the **Folder Select** menu.



### Creating a New Folder at Startup

If you turn the camera on while pressing the **ON** button, a new folder will be created. After performing this operation, be sure that “1” is showing in the frame number display in the control panel on top of the camera before taking a photograph. If you take a photograph before the frame number display shows “1,” the photograph will be recorded in the last folder in use before the new folder was created. Note that no new folder will be created if the memory card already contains an empty folder. An error will occur if the camera is turned on with the **ON** button held down when the current folder is numbered 999. If such an error occurs, the letters **ERR** will blink on and off in the control panel display on top of the camera.

### Displaying Histograms and Highlights: The Display Mode Menu

The options selected in this menu determine whether a histogram and highlight display are included in photograph information when an image is played back.

In the playback menu, highlight **Display Mode** and press the multi-selector to the right. The menu shown at right will be displayed. Highlight the desired option and press the multi-selector to the right to put your choice into effect and return to the playback menu.



The following options are available:

Option	Description
<b>Image only</b>	Histogram and highlights information are not included in the photo-information display.
<b>Histogram</b>	A page including a histogram showing the distribution of tones in the image is added to the photo-information display.
<b>Highlights</b>	A page showing image highlights is added to the photo-information display. Highlights (brighter areas of the image) are indicated by a flashing border.
<b>Both</b>	Two pages are added to the photo-information display, one showing a histogram and the other image highlights.



**For more information on:**

pg. 186 The playback menu

pg. 126 Histogram and highlights displays

The setup menu contains options for formatting memory cards and controlling video output and monitor settings.

## Formatting Memory Cards: The Format Menu

To format memory cards for use in your Nikon digital camera, highlight **Format** in the setup menu and press the multi-selector to the right. The menu shown at right will be displayed. Highlight the desired option and press the **FUNC** button to put your choice into effect.



The following options are available:

Option	Description
<b>NO</b>	Select this option to return to the setup menu without formatting the memory card.
<b>YES</b>	Formatting begins as soon as the <b>FUNC</b> button is pressed to select this option; the operation can not be cancelled. Once formatting is complete, the message “No Images in current folder” will be displayed. Press the <b>MENU</b> button to return to the setup menu.

### Choosing the Video Standard: The Video Output Menu

The **Video Output** menu is used to select the standard for video output when the camera is connected to a television or VCR. The default setting is NTSC. When connecting the camera to PAL device, the setting must be changed.

In the setup menu, highlight **Video Output** and press the multi selector to the right. The menu shown at right will be displayed. Highlight the desired option and press the multi selector to the right to put your choice into effect and return to the setup menu.

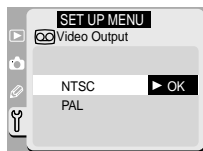

The following options are available:

Option	Description
<b>NTSC</b>	Select this option when connecting the camera to NTSC devices.
<b>PAL</b>	Select this option when connecting the camera to PAL devices.

### Adjusting Monitor Brightness: The LCD Brightness Menu

This option controls monitor brightness. In the setup menu, highlight **LCD Brightness** and press the multi selector to the right. The menu shown at right will be displayed. There are five levels of brightness to choose from; press the multi selector up to increase brightness, or down to decrease brightness. The number indicates the amount of brightness, with 5 being the brightest setting. Press the multi selector to the right to put your choice into effect and return to the setup menu.



At a video-mode setting of PAL, the number of pixels in the video output will be selectively reduced, with the result that images displayed on any PAL-compliant video device to which the camera is connected will show a drop in resolution.



**For more information on:**

pg. 190 The setup menu

## The Monitor Off Menu

When the camera is operated on battery power, the monitor turns off automatically if no operations are performed for twenty seconds. This time limit can be changed using the **Monitor Off** menu.

In the setup menu, highlight **Monitor Off** and press the multi selector to the right. The menu shown at right will be displayed. Highlight the desired option and press the **FUNC** button or press the multi selector to the right to put your choice into effect and return to the setup menu.

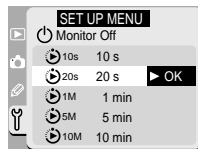

When the camera is powered by an AC adapter (available separately), the monitor remains on for ten minutes when no operations are performed, regardless of the setting in the **Monitor Off** menu.



### Restoring the Monitor Display

To turn the monitor on again after it has turned off automatically, press the  button.



### 18—Monitor Off Delay pg. 170

The time until the monitor turns off automatically can also be adjusted using this setting.

## Television Playback

Your Nikon digital camera can be connected to a television or video cassette recorder (VCR) using the video cable provided, allowing the monitor display to be viewed on a television screen or recorded on video tape.

Open the cover protecting the camera's VIDEO OUT and DC-IN connectors.

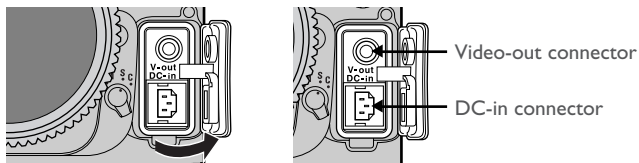

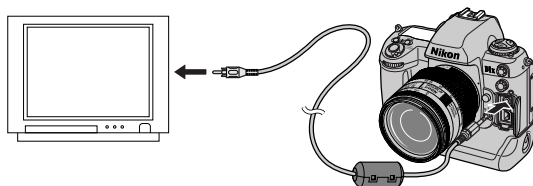

Connect the camera to the video device as shown below.



Connect this end  
of the cable to the  
video device



Connect this end  
of the cable to the  
camera

While the video cable is connected, the camera functions normally in all respects. The image in the monitor will be displayed on the television screen while the monitor is on. We recommend that the camera be powered with an AC adapter (available separately) during television playback to avoid draining the battery. For information on connecting an AC adapter, see the documentation provided with the adapter. When connected to AC adapter, the monitor will power off automatically if no operations are performed for ten minutes, regardless of the setting in the **Monitor Off Delay** (Custom Setting 18;  pg. 170) or **Monitor Off** ( pg. 145) menus.

The default setting is NTSC. When connecting the camera to PAL device, the setting must be changed.

---

## Connecting and Disconnecting the Video Cable

---

Be sure the camera is off before connecting or disconnecting the video cable.



At a video-mode setting of PAL, the number of pixels in the video output will be selectively reduced, with the result that images displayed on any PAL-compliant video device to which the camera is connected will show a drop in resolution.

---

## Video Output ( pg. 144)

---

The **Video Output** option in the setup menu offers a choice of NTSC and PAL video standards for output to video devices.



## Connecting to a Computer

Your Nikon digital camera is equipped with an IEEE 1394 interface for connection to a computer. With Nikon View 4 installed on your computer, you can view photographs on the computer monitor or copy them to disk. Using Nikon Capture 2 camera control software, you can adjust camera settings remotely and prepare photographs for printing or use in a commercial production work-flow.

### *Before You Begin*

Before connecting the camera to a computer:

- Be sure that you have completed installation of the necessary software and have read the software manuals thoroughly
- Check that your system satisfies the requirements listed in the software manuals
- Turn the camera off and ensure that a battery is inserted or the camera connected to an AC adapter

To ensure a continuous supply of power while the camera is connected, we recommend that you use an AC adapter (available separately).

### *Connecting the Camera to a Computer*

- 1 When connecting the camera to a computer via the IEEE 1394 interface, use an IEEE 1394 cable (available separately). Open the cover protecting the camera's IEEE 1394 connector and connect the devices as shown below.

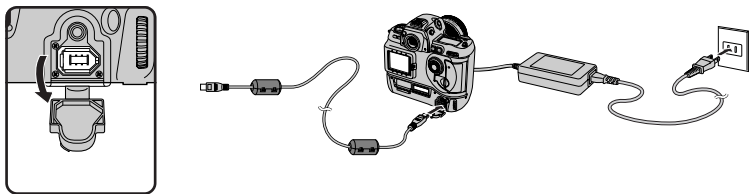

For information on connecting IEEE 1394 devices, see the documentation provided with your computer or IEEE 1394 expansion board or card. IEEE 1394 devices can be connected or disconnected when the computer and the device are still on (so-called "hot plug" or "hot connect/disconnect") without the need to turn off either device or restart the computer system.

- 2** To allow data to be transferred between the computer and the camera, turn the camera mode dial to PC. The computer will not recognize the camera if the mode dial is set to any other position.

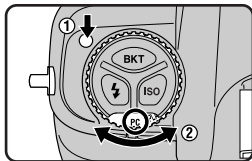

Note that the “hot plug” support provided by the IEEE 1394 interface makes it possible to reverse steps 1 and 2 by turning the camera on and setting the mode dial to PC before connecting the device to the computer:

If the camera is properly connected and Nikon Capture 2 is running, the control panel on top of the camera will show **PC** (**PC** is not displayed when Nikon View 4 is used).

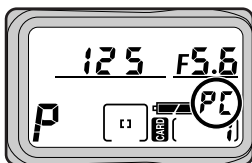

If the mode dial is set to PC and the camera is not connected to a computer, or if it is connected when neither Nikon View 4 nor Nikon Capture 2 is running, the camera will function as in single-frame or continuous mode, the only difference being that the shooting mode (single-frame or continuous) is selected using Custom Setting 30 (**PC Shooting Mode**).

- 3** To terminate the connection between the camera and computer, exit Nikon View 4 or Nikon Capture 2 and turn the camera mode dial to another setting. If you are using Nikon Capture 2, wait until **PC** is no longer displayed in the control panel before disconnecting the cable.

## M

Do not turn the camera off while data transfer is in progress.

## Shooting Speed (Nikon Capture 2)

The shooting speed may drop when the camera shutter-release button is used to take photographs with the camera connected to a computer running Nikon Capture 2.



**For more information on:**

pg. 180 Custom Setting 30

## **Nikon View 4**

Using Nikon View 4, you can browse the photographs stored on the camera's memory card, copy photographs to disk, and catalog photographs using third-party database software. The browser function can be used to delete unwanted shots from the memory card, copy images to disk, and view photographs (including photos shot in YCbCr-TIFF and RAW formats) full screen on your computer monitor. See the Nikon View 4 reference manual for details.

### *System Requirements for Nikon View 4*

#### Windows

<b>OS</b>	Windows 98 Second Edition (SE) <sup>1</sup> , Windows 2000 <sup>1</sup> , Windows Millennium Edition <sup>1</sup>
<b>CPU</b>	MMX Pentium or better
<b>RAM</b>	32 MB (64 MB or more recommended)
<b>Hard disk space</b>	Free disk space equivalent to least double the capacity of the camera memory card required on disk to which Windows has been installed <sup>2</sup>
<b>Video resolution</b>	640 × 480 pixels with 16-bit color (High Color) (800 × 600 pixels or greater with 24-bit color [True Color] recommended)
<b>Miscellaneous</b>	<ul style="list-style-type: none"><li>• CD-ROM drive required for installation</li><li>• OHCI-compliant IEEE 1394 interface<sup>3</sup></li></ul>

- 1 Only pre-installed versions are supported.
- 2 For the amount of disk space necessary when used with other software, refer to the documentation provided with the software in question.
- 3 Required if the camera is to be connected to the computer. The camera may not function as expected when connected to an IEEE 1394 hub. For information on IEEE 1394 expansion boards or cards that have been tested and approved for use with your Nikon digital camera, see the web-sites listed below.



Software specifications are subject to change without notice. For the latest information and software upgrades, visit the following web-sites:

- For the U.S.A.: <http://www.nikonusa.com/>
- For Europe: <http://www.nikon-euro.com/>
- For Asia, Oceania, the Middle East, and Africa: <http://www.nikon-asia.com/>

## Macintosh

<b>OS</b>	Mac OS 8.6 <sup>1</sup> , 9.0, 9.1
<b>Model</b>	iMac DV, Power Mac G3 (Blue & White), Power Book G3 or later, Power Mac G4 or later
<b>RAM</b>	32 MB (64 MB or more recommended)
<b>Hard disk space</b>	Free disk space equivalent to least double the capacity of the camera memory card required on the start-up disk <sup>2</sup>
<b>Video resolution</b>	640 × 480 pixels with 16-bit color (thousands of colors) (800 × 600 pixels or greater with 24-bit color [millions of colors] recommended)
<b>Miscellaneous</b>	<ul style="list-style-type: none"> <li>• CD-ROM drive required for installation</li> <li>• Built-in FireWire interface<sup>3</sup></li> </ul>

- 1 If you are using Mac OS 8.6, upgrade to version 2.3.3 of the Apple FireWire driver.
- 2 For the amount of disk space necessary when used with other software, refer to the documentation provided with the software in question.
- 3 Required if the camera is to be connected to the computer. The camera may not function as expected when connected to an IEEE 1394 hub.

## **Nikon Capture 2**

Nikon Capture 2 can be used to control the camera when it is connected to a computer, and also to edit photographs. You can also simplify studio photography by recording photographs directly to the computer's hard disk, without first storing them on the memory card. Nikon Capture 2 also supports batch processing and editing of all images created with the camera, including RAW data. See the Nikon Capture 2 manual for details.

### *System Requirements for Nikon Capture*

#### Windows

<b>OS</b>	Windows 98 Second Edition (SE) <sup>1</sup> , Windows 2000 <sup>1</sup> , Windows Millennium Edition <sup>1</sup>
<b>CPU</b>	Pentium II, Celeron, or better
<b>RAM</b>	64 MB (128 MB or more recommended) <sup>2</sup>
<b>Hard disk space</b>	40 MB free while Nikon Capture is running (200 MB or more recommended) <sup>2</sup>
<b>Video resolution</b>	640 × 480 pixels with 16-bit color (High Color) (800 × 600 pixels or greater with 24-bit color [True Color] recommended)
<b>Miscellaneous</b>	<ul style="list-style-type: none"><li>• CD-ROM drive required for installation</li><li>• OHCI-compliant IEEE 1394 interface<sup>3</sup></li></ul>

1 Only pre-installed versions are supported.

2 Depending on the number of images captured, more may be required.

3 Required if the camera is to be connected to the computer. The camera may not function as expected when connected to an IEEE 1394 hub. For information on IEEE 1394 expansion boards or cards that have been tested and approved for use with your Nikon digital camera, see the web-sites listed below.



Software specifications are subject to change without notice. For the latest information and software upgrades, visit the following web-sites:

- For the U.S.A.: <http://www.nikonusa.com/>
- For Europe: <http://www.nikon-euro.com/>
- For Asia, Oceania, the Middle East, and Africa: <http://www.nikon-asia.com/>

## Macintosh

<b>OS</b>	Mac OS 8.6 <sup>1</sup> , 9.0, 9.1
<b>Model</b>	iMac DV, Power Mac G3 (Blue & White), Power Book G3 or later, Power Mac G4 or later
<b>RAM</b>	64 MB (128 MB or more recommended) <sup>2</sup>
<b>Hard disk space</b>	40 MB free while Nikon Capture is running (200 MB or more recommended) <sup>2</sup>
<b>Video resolution</b>	640 × 480 pixels with 16-bit color (thousands of colors) (800 × 600 pixels or greater with 24-bit color [millions of colors] recommended)
<b>Miscellaneous</b>	<ul style="list-style-type: none"><li>• CD-ROM drive required for installation</li><li>• Built-in FireWire interface<sup>3</sup></li></ul>

1 If you are using Mac OS 8.6, upgrade to version 2.3.3 of the Apple FireWire driver.

2 Depending on the number of images captured, more may be required.

3 Required if the camera is to be connected to the computer. The camera may not function as expected when connected to an IEEE 1394 hub.

## Reading Photographs from Memory Cards

When a memory card is inserted in an EC-AD1 PC-card adapter (available separately), its contents can be viewed using any card slot or PC card reader that supports PCMCIA type-II ATA memory cards.

- 1 Remove the memory card from the computer and insert it in the PC card adapter as shown at right.

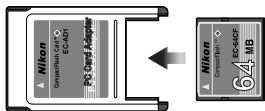

- 2 Insert the adapter in a computer equipped with a card slot or PC card reader that supports ATA memory cards. For detailed instructions, see the documentation provided with your computer or card reader.

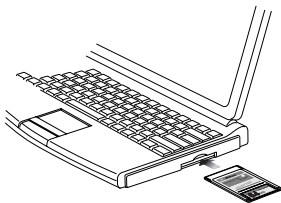

- 3 The card will function as a disk. Photographs recorded at settings of FINE, NORMAL, or BASIC can be viewed using any application that supports JPEG. Images recorded at a setting of HIGH/RGB-TIFF can be opened in applications that support the TIFF format. Nikon Capture 2 or Nikon View 4 is required to view photographs taken at settings of HIGH/RAW or HIGH/YCbCr-TIFF.



Depending on your operating environment, it may be necessary to install drivers, register the card with the system, or adjust settings to configure the computer to read microdrives CompactFlash memory cards. For details, see the documentation provided with your computer or operating system.

## CUSTOM SETTINGS AND OTHER MENUS

- **Custom Settings**  
..... pp. 156–185
- **Other Camera Menus**  
..... pp. 186–191

---

### About This Section

---

This section describes the options available in the custom settings menu and provides an index to the shooting, playback, and setup menus.

---



Your Nikon digital camera is equipped with a menu of custom settings (Custom Settings 0–35), which can be used to customize many aspects of camera operation. The Custom Settings Menu can be used when the camera is in single-frame, continuous, self-timer or PC mode.

## Choosing a Custom Settings Bank

Before adjusting custom settings, choose the settings bank that will be used to store the changes. The camera can store settings in “banks” that can be recalled at any time, allowing you to create up to four combinations of settings for common tasks or shooting situations and recall them quickly as desired.

By default, any changes to custom settings are saved in Bank A. To select another settings bank:

### 1 Display the camera menus

Turn the camera on (A) and press the **MENU** button (B). The menu for the current operating mode will be displayed in the monitor (C).

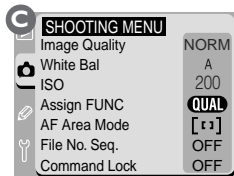
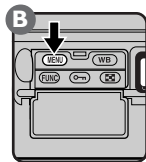
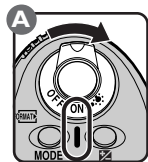

### 2 Display the CSM MENU

Unlock the multi selector and press it up or down (A) until the custom settings menu is displayed (B).

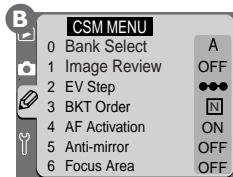
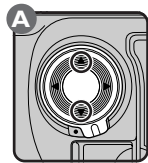

### 3 Display the Custom Setting Bank menu

Press the multi selector to the right to enter the custom settings menu, then press the multi selector up or down to highlight **F0 Custom Setting Bank**. Press the multi selector to the right to display the menu shown below.

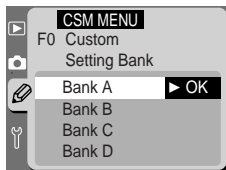

### 4 Choose a custom settings bank

Press the multi selector up or down to highlight the desired settings bank, then press the multi selector to the right to put your choice into effect and return to the custom settings menu.

Settings stored in the selected bank will automatically be put into effect when the bank is chosen. Any changes to custom settings made after the bank is selected will be saved in the selected bank.



#### Using the Function Button to Adjust Custom Settings

If **CSM** is selected in the **Assign FUNC** sub-menu, the **FUNC** button can be used to select the custom settings bank. Keeping the **FUNC** button pressed, rotate the main command dial until custom setting 0 appears in the rear control panel. The currently selected bank will be displayed following the custom settings number. To select a new settings bank, rotate the sub-command dial while pressing the **FUNC** button. Release the **FUNC** button to put your selection into effect.

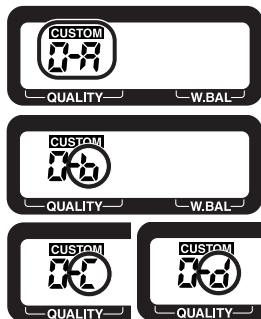

**For more information on:**

pg. 116 The **Assign FUNC** sub-menu

## Adjusting Custom Settings

Changes to custom settings in the current settings bank are made from the custom settings menu.

### 1 Display the camera menus

Turn the camera on (A) and press the **MENU** button (B). The menu for the current operating mode will be displayed in the monitor (C).

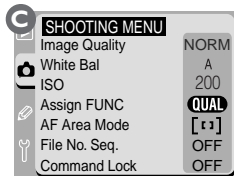
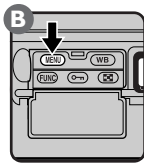
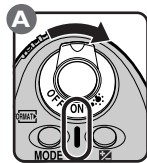

### 2 Display the CSM MENU

Unlock the multi selector and press it up or down (A) until the custom settings menu is displayed (B).

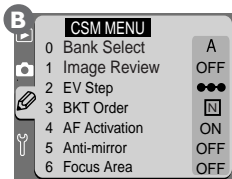
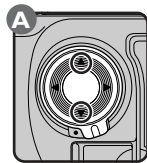

### 3 Select a custom setting

Press the multi selector to the right to enter the custom settings menu, then press the multi selector up or down (A) to highlight the desired setting (B).

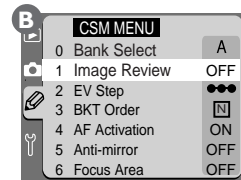
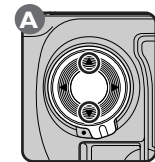

#### 4 Choose an option for the selected setting

Press the multi selector to the right (A) to display a menu of options for the selected setting (B).

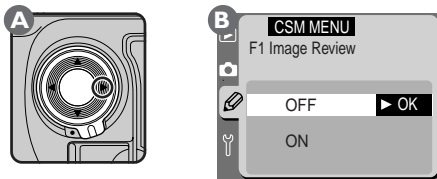

Press the multi selector up or down to highlight the desired option, then press the selector to the right to put your choice into effect and return to the custom settings menu. To return to the custom settings menu without changing settings, press the multi selector to the left.

When custom settings for the current settings bank are modified from their default values, the **CUSTOM** indicator will be displayed in the rear control panel.

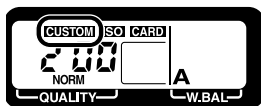

#### Using the Function Button to Adjust Custom Settings

If **CSM** is selected in the **Assign FUNC** sub-menu, the **FUNC** button can be used to make changes to custom settings. Keeping the **FUNC** button pressed, rotate the main command dial until the desired settings number appears in the rear control panel. Adjust the selected setting by rotating the sub-command dial while pressing the **FUNC** button. Release the **FUNC** button to put your selection into effect.



**For more information on:**

pg. 116 The **Assign FUNC** sub-menu

## Custom Setting Options

The pages that follow list the options available in the custom settings menu and the settings available for each option. Options are listed together with the setting and option numbers that appear in the rear control panel when custom settings are adjusted using the **FUNC** button.

### Custom Setting 0: Custom Setting Bank

The camera can store up to four banks of custom settings, Bank A, Bank B, Bank C, and Bank D. To activate the settings in a settings bank, select the desired bank from the **Custom Setting Bank** menu. Any changes to settings are stored in the currently selected bank.

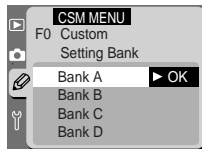

Option	No.	Description
<b>Bank A</b> (default)	0-A	Settings Bank A selected
<b>Bank B</b>	0-b	Settings Bank B selected
<b>Bank C</b>	0-c	Settings Bank C selected
<b>Bank D</b>	0-d	Settings Bank D selected





**For more information on:**

pg. 159 Using the **FUNC** button to adjust custom settings

### Custom Setting 1: Image Review

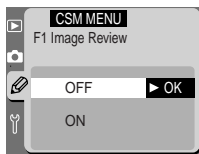
Using this setting, you can choose whether images are displayed automatically in the LCD monitor while they are recorded to the memory card, or if images are only displayed when the  button is pressed.



Option	No.	Description
<b>OFF</b> (default)	<b>1-0</b>	Images are only displayed when the  button is pressed.
<b>ON</b>	<b>1-2</b>	Images are displayed in the monitor automatically while being recorded to the memory card after removing your finger from the pressed shutter-release button.

### Custom Setting 2: EV Steps for Exposure Control

By default, adjustments to settings that affect exposure (shutter speed, aperture, exposure compensation, and auto bracketing) are made in increments equivalent to  $\frac{1}{3}$  EV ( $\frac{1}{3}$  step). This setting can be used to set the size of the increments used to  $\frac{1}{2}$  or 1 step. Changes to EV steps for exposure control are reflected in the exposure display in the viewfinder and in the control panel on top of the camera.

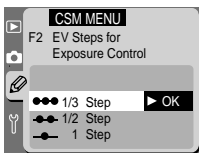

Option	No.	Description
<b>1/3 Step</b> (default)	<b>2-3</b>	Adjustments to exposure settings are made in increments equivalent to $\frac{1}{3}$ EV ( $\frac{1}{3}$ step).
<b>1/2 Step</b>	<b>2-2</b>	Adjustments to exposure settings are made in increments equivalent to $\frac{1}{2}$ EV ( $\frac{1}{2}$ step).
<b>1 Step</b>	<b>2-1</b>	Adjustments to exposure settings are made in increments equivalent to 1 EV (1 step).



**For more information on:**

### Custom Setting 3: Bracketing Order

By default, auto bracketing proceeds in the order given in the reference section (📷 pg. 100). If desired, the camera can be programmed to perform bracketing in order from the lowest exposure value (underexposure) to the highest exposure value (overexposure).

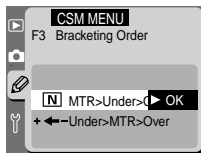

Option	No.	Description
<b>MTR&gt;Under&gt;Over</b> (default)	3-0	Bracketing performed in the order given in the reference section (📷 pg. 101).
<b>Under&gt;MTR&gt;Over</b>	3-1	Bracketing performed in order from lowest to highest value.

### Custom Setting 4: AF Activation

By default, both the shutter-release button and the AF-ON buttons can be used activate autofocus. If you prefer, you can set the camera so that an autofocus operation is only performed when one of the AF-ON buttons is pressed.

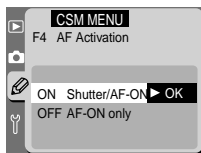

Option	No.	Description
<b>Shutter/AF-ON</b> (default)	4-0	Autofocus can be performed using the AF-ON buttons or by pressing the shutter-release button half-way.
<b>AF-ON only</b>	4-1	Autofocus can only be performed using the AF-ON buttons.



**For more information on:**

pg. 100 Auto bracketing

### Custom Setting 5: Anti-mirror-shock mode

By default, the mirror is raised out of the way of the CCD at the same time that the shutter opens to create an exposure. To minimize camera shake, exposure can be delayed until after the mirror has been raised and any vibrations have died away.

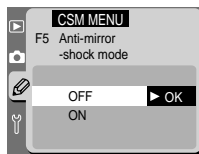

Option	No.	Description
<b>OFF</b> (default)	5-0	The shutter is released as soon as the mirror is raised.
<b>ON</b>	5-1	Exposure is delayed until after mirror is raised to minimize camera shake for situations in which very slight vibrations can blur photographs, such as microscope photography.

### Custom Setting 6: Focus Area Select

At default settings, the focus-area display is bounded by the four outer focus areas. Thus, for example, pressing the multi-selector up when the top focus area is selected will have no effect. This can be changed so that focus-area selection “wraps around” from top to bottom and right to left. In this case, pressing the multi-selector up when the top focus area is highlighted selects the bottom focus area, while pressing it down when the bottom focus area is highlighted selects the top focus area. Similarly, pressing the multi-selector to the right when the right area is highlighted selects the left focus area.

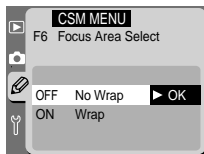

Option	No.	Description
<b>No Wrap</b> (default)	6-0	Wrap-around disabled.
<b>Wrap</b>	6-1	Wrap-around in effect.



**For more information on:**



## Custom Setting 7: AE Lock

By default, exposure is locked by pressing the AE-L/AF-L button. This can be changed so that exposure is locked by pressing the shutter-release button halfway.

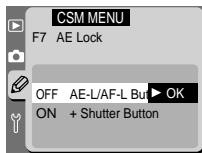

Option	No.	Description
<b>AE-L/AF-L Button</b> (default)	7-0	Pressing the AE-L/AF-L button locks exposure.
<b>+ Shutter Button</b>	7-1	Exposure is locked while the shutter-release button is pressed halfway.

## Custom Setting 8: Mirror Lock-up for CCD Cleaning

This option is used to lock the mirror in the up position while inspecting or cleaning the low-pass filter that covers the CCD. See "Technical Notes: Caring for Your Camera" (pg. 196).

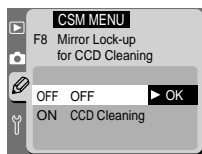

Option	No.	Description
<b>OFF</b> (default)	8-0	Mirror not locked in up position.
<b>CCD Cleaning</b>	8-1	Mirror locked in up position. To ensure that power is available to lower the mirror after cleaning, this option only takes effect when the camera is powered by an EH-4 AC adapter (available separately).



**For more information on:**

pg. 96 Auto-exposure lock

**Custom Setting 9: Dynamic AF, Single-Servo**

This option is used to disable or enable closest-subject priority when dynamic AF is used with single-servo autofocus.

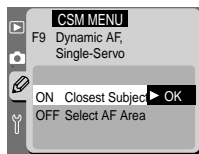

Option	No.	Description
<b>Closest Subject</b> (default)	9-0	Camera assesses distance to subjects in each focus area and selects the subject closest to the camera.
<b>Select AF Area</b>	9-1	Camera focuses on the subject in the selected focus area.

**Custom Setting 10: Dynamic AF, Continuous-Servo**

This option is used to enable or disable closest-subject priority when dynamic AF is used with continuous-servo autofocus.

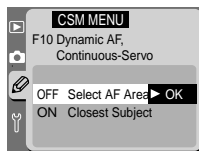

Option	No.	Description
<b>Select AF Area</b> (default)	10-0	Camera focuses on the subject in the selected focus area.
<b>Closest Subject</b>	10-1	Camera assesses distance to subjects in each focus area and selects the subject closest to the camera.

**2—EV Steps for Exposure Control (pg. 161)**

By default, adjustments to aperture and shutter speed are made in increments equivalent to  $\frac{1}{3}$  EV ( $\frac{1}{3}$  step). If desired, the size of the increments can be increased to  $\frac{1}{2}$  or 1 step.

**For more information on:**

pg. 74 AF-area mode

## Custom Setting 11: AE/Flash Bracketing

By default, both auto-exposure and flash exposure change with each shot taken while auto bracketing is in effect. This option can be used to change camera settings so that bracketing affects only one of auto-exposure and flash exposure.

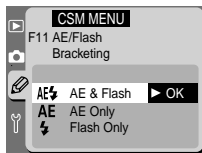

Option	No.	Description
<b>AE &amp; Flash</b> (default)	11-A5	Both auto-exposure and flash exposure change with each shot.
<b>AE Only</b>	11-AE	Only auto-exposure changes with each shot; flash exposure remains fixed.
<b>Flash Only</b>	11-5b	Only flash exposure changes with each shot; auto-exposure remains fixed.

## Custom Setting 12: Assign Command Dial

By default, the main command dial controls shutter speed (shutter-priority auto and manual exposure modes) while the sub-command dial controls aperture (aperture-priority and manual exposure modes). This relationship can be reversed using this option.

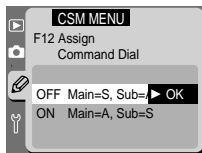

Option	No.	Description
<b>Main=S, Sub=A</b> (default)	12-0	Main command dial controls shutter speed, sub-command dial aperture.
<b>Main=A, Sub=S</b>	12-1	Main command dial controls aperture, sub-command dial shutter speed.



**For more information on:**

### Custom Setting 13: Easy Exposure Compensation

If desired, exposure compensation can be set with the command dials alone, without pressing the  button. Exposure compensation can be set to values between  $-5$  EV and  $+5$  EV.

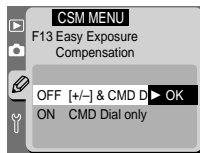

Option	No.	Description			
[+/-] & CMD Dial (default)	13-0	Exposure compensation is set by pressing the  button while rotating the main command dial.			
CMD Dial only	13-1	Exposure compensation is set using one of the command dials. The command dial used to set exposure compensation varies with the exposure mode and the option chosen in Custom Setting 12.			
		<b>Custom Setting 12</b>			
			Main=S, Sub=A	Main=A, Sub=S	
		Exposure mode	P	Sub-command dial	Sub-command dial
			S	Sub-command dial	Main command dial
A	Main command dial		Sub-command dial		
M	—		—		



## 2—EV Steps for Exposure Control ( pg. 161)

By default, adjustments to aperture and shutter speed are made in increments equivalent to  $\frac{1}{3}$  EV ( $\frac{1}{3}$  step). If desired, the size of the increments can be increased to  $\frac{1}{2}$  or 1 step.



### For more information on:

pg. 98 Exposure compensation

## Custom Setting 14: Center Weight Area

When determining exposure, center-weighted metering assigns the greatest weight to a circle in the center of the frame. This option is used to set the size of the circle as shown below.

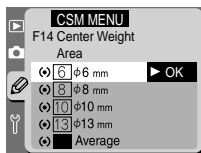

Option	No.	Metering area
φ6 mm	14-6	Greatest weight assigned to a 6 mm (0.24") circle
φ8 mm (default)	14-8	Greatest weight assigned to an 8 mm (0.32") circle
φ10 mm	14-10	Greatest weight assigned to a 10 mm (0.39") circle
φ13 mm	14-13	Greatest weight assigned to a 13 mm (0.51") circle
Average	14-A	Exposure based on the average for the entire frame

## Custom Setting 15: Auto Meter-Off Delay

This setting is used to set the length of time exposure indicators are displayed in the control panel on top of the camera after the camera is turned on or after the shutter-release button is pressed halfway. Note that increasing the time for auto meter-off delay reduces battery performance.

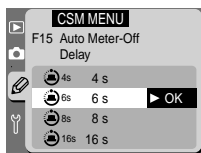

Option	No.	Time indicators remain active (approx.)
4 s	15-4	Four seconds
6 s (default)	15-6	Six seconds
8 s	15-8	Eight seconds
16 s	15-16	Sixteen seconds



**For more information on:**

### Custom Setting 16: Self-timer Delay

This setting is used to specify the length of the delay from the time the shutter-release button is pressed to the time the shutter is released in self-timer mode.

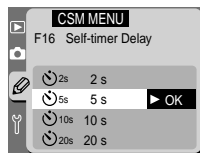

Option	No.	Shutter release delayed by (approx.)
2 s	16-2	Two seconds
5 s	16-5	Five seconds
10 s (default)	16-10	Ten seconds
20 s	16-20	Twenty seconds

### Custom Setting 17: LCD Illumination

By default, the control panels are illuminated when the power switch is turned to . If desired, the camera can be set so that the control panels light when any button is pressed.

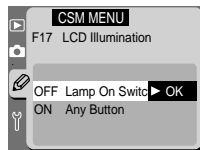

Option	No.	Description
Lamp On Switch (default)	17-0	Control panels are illuminated only when power switch is turned to .
Any Button	17-1	Control panels are illuminated when any button is pressed.



**For more information on:**

## Custom Setting 18: Monitor Off Delay

This item controls the length of time the monitor remains on when no operations are performed. Note that increasing the monitor off delay reduces battery life.

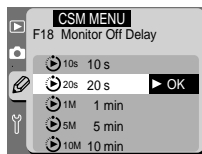

Option	No.	Monitor stays on for (approx.)
10 s	18-0	Ten seconds
20 s (default)	18-1	Twenty seconds
1 min	18-2	One minute
5 min	18-3	Five minutes
10 min	18-4	Ten minutes

### Custom Setting 19: Aperture Control during Zoom

On lenses with a variable focal length (for example, Micro Nikkor or zoom lenses), maximum aperture varies with focal length. This setting determines how such changes in the maximum aperture affect the  $f$ -number specified by the user in aperture-priority auto or manual exposure modes. By default, aperture remains fixed at the specified  $f$ -number while the lens is zoomed in or out. If desired, the camera can instead be set to vary the  $f$ -number with focal length so that aperture remains a fixed number of steps from the maximum setting. Suppose, for example, that a 70–210 mm,  $f/4$ –5.6 AF Zoom-Nikkor lens is mounted on the camera, and an aperture of  $f/8$  is selected when the lens is zoomed out to 70 mm. At this zoom position,  $f/8$  is two steps from the maximum aperture of  $f/4$ . Now imagine that the lens is zoomed in to 210 mm. If fixed aperture is selected, aperture will remain constant at  $f/8$ . If aperture is set to vary with focal length, however, aperture will decrease to  $f/11$ , two steps from  $f/5.6$ , the maximum value for this focal length.

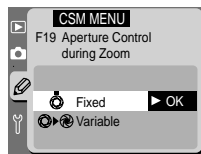

Option	No.	Description
<b>Fixed</b> (default)	<b>19-0</b>	Aperture does not vary with lens focal length.
<b>Variable</b>	<b>19-1</b>	Aperture varies with lens focal length.



**For more information on:**



## Custom Setting 20: ISO Step Value

By default, adjustments to sensitivity (ISO equivalency) are made in increments equivalent to  $\frac{1}{3}$  EV ( $\frac{1}{3}$  step). This setting can be used to set the size of the increments to  $\frac{1}{2}$  or 1 step.

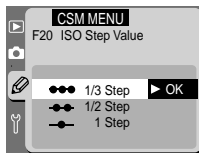

Option	No.	Description
<b>1/3 Step</b> (default)	<b>20-3</b>	Adjustments to sensitivity are made in increments equivalent to $\frac{1}{3}$ EV ( $\frac{1}{3}$ step).
<b>1/2 Step</b>	<b>20-2</b>	Adjustments to sensitivity are made in increments equivalent to $\frac{1}{2}$ EV ( $\frac{1}{2}$ step).
<b>1 Step</b>	<b>20-1</b>	Adjustments to sensitivity are made in increments equivalent to 1 EV (1 step).

## Custom Setting 21: AE-L/AF-L Button

By default, both focus and exposure are locked while the AE-L/AF-L button is pressed. Custom Setting 21 controls the behavior of this button as shown below.

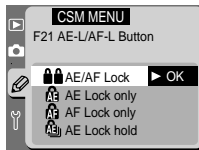

Option	No.	Description
<b>AE/AF Lock</b> (default)	<b>21-0</b>	Both focus and exposure are locked while the AE-L/AF-L button is pressed.
<b>AE Lock only</b>	<b>21-1</b>	Exposure is locked while the AE-L/AF-L button is pressed. Focus is not locked.
<b>AF Lock only</b>	<b>21-2</b>	Focus is locked while the AE-L/AF-L button is pressed. Exposure is not locked.
<b>AE Lock hold</b>	<b>21-3</b>	Pressing the AE-L/AF-L button locks exposure. Exposure remains locked until the button is pressed again.



**For more information on:**

pg. 62 Sensitivity (ISO equivalency)

pg. 78 Focus lock

### Custom Setting 22:Aperture Setting

By default, aperture can only be adjusted by means of the sub-command dial, not the aperture ring on the lens. Using this item, you can instead set the camera so that aperture can only be adjusted using the lens aperture ring, not the sub-command dial.

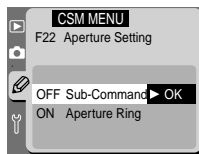

Option	No.	Description
<b>Sub-Command Dial</b> (default)	<b>22-0</b>	Aperture can only be adjusted using the sub-command dial.
<b>Aperture Ring</b>	<b>22-1</b>	Aperture can only be adjusted using the lens aperture ring. When this option is in effect, the aperture display in the control panel shows aperture in increments of one step. Note that even if aperture selection is assigned to the main command dial in Custom Setting 12, aperture can only be adjusted using the lens aperture ring.



**For more information on:**

pg. 96 Auto-exposure lock

pg. 88 Aperture selection

pg. 166 Custom Setting 12

### Custom Setting 23: Image Sharpening

By default, the camera processes photographs to increase sharpness, making edges more distinct. This setting controls the amount of sharpening performed.

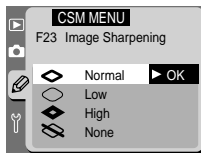

Option	No.	Description
<b>Normal</b> (default)	23-0	Image is processed to increase sharpness, making edges in the image more distinct.
<b>Low</b>	23-1	Image is still processed to increase sharpness, but the amount of sharpening is less than default level.
<b>High</b>	23-2	Image is processed to increase sharpness beyond default level.
<b>None</b>	23-3	No sharpening is performed.

### Custom Setting 24: Tone Compensation

As photographs are saved to the memory card, the camera adjusts tones in the image to optimize contrast. This adjustment is performed by means of tone curves that define the relationship between the tone distribution in the original image and the compensated result. Using Custom Setting 24, you can select a curve suited to the subject and the device on which the image will be printed or displayed.

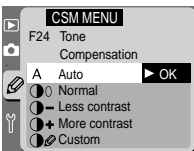

Option	No.	Description
<b>Auto</b> (default)	24-0	When matrix metering is selected, the camera automatically optimizes contrast by selecting a curve equivalent to “Normal,” “Less Contrast,” or “More Contrast.” When another metering method is selected, this option is equivalent to <b>Normal</b> .
<b>Normal</b>	24-1	A standard curve is used. This curve is suitable for most scenes, ranging from dark through to bright.
<b>Less contrast</b>	24-2	Use this curve to achieve a softer image, for example, with portraits shot in direct sunlight, when your subject’s features would otherwise tend to be “washed out.”
<b>More contrast</b>	24-3	This curve enhances detail, making it suited to misty landscape shots and other low-contrast subjects.
<b>Custom</b>	24-C5	A user-defined curve downloaded to the camera from Nikon Capture 2 is used. If no curve has been downloaded to the camera, this option is equivalent to <b>Normal</b> .



**For more information on:**

### Custom Setting 25: C-Mode Shooting Speed

This item sets the rate at which photographs are taken in continuous mode.

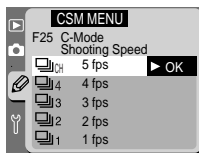

Option	No.	Description
5 fps (default)	25-CH	Photographs are taken at a rate of five frames per second.
4 fps	25-4	Photographs are taken at a rate of four frames per second.
3 fps	25-3	Photographs are taken at a rate of three frames per second.
2 fps	25-2	Photographs are taken at a rate of two frames per second.
1 fps	25-1	Photographs are taken at a rate of one frame per second.

### Custom Setting 26: C-Mode Max Shots

Using this item, the user can specify the maximum number of photographs that can be stored in the temporary memory buffer when shooting in continuous mode. Options range from one to forty shots; the default setting is forty. Note, however, that no more than twenty-seven RAW images can be stored in the buffer at a time, even when the maximum chosen using this setting is twenty-seven or higher.



**For more information on:**

### Custom Setting 27: Display Mode

This item determines whether additional pages showing a histogram or image highlights are included in the photo information display when photographs are played back in the monitor. This setting can also be adjusted using the **Display Mode** item in the playback menu.

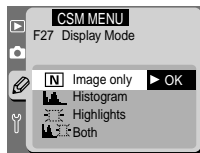

Option	No.	Description
<b>Image only</b> (default)	27-0	Only photograph and standard photo information displayed.
<b>Histogram</b>	27-1	A page with a histogram showing the distribution of tones in the image is added to the photo information display.
<b>Highlights</b>	27-2	A page showing image highlights is included in the photo information display.
<b>Both</b>	27-3	Two pages are added to the photo information display one showing a histogram and the other highlights.



**For more information on:**

pg. 126 Histogram and highlights displays

pg. 142 The Display Mode sub-menu

## Custom Setting 28: NEF(RAW) Image Save

This item determines whether the RAW image format is available at an image quality setting of High, and whether RAW-format images will be compressed. Note that Nikon Capture 2 or Nikon View 4 or later is required when viewing RAW images on a computer.

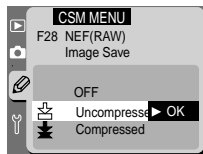

Option	No.	Description
OFF	28-0	High-quality images can only be saved in TIFF format.
Uncompressed (default)	28-1	RAW images are saved without compression.
Compressed	28-2	RAW images are compressed using a “lossless” algorithm that reduces file size from around fifty to sixty percent without affecting image quality.



**For more information on:**

- pg. 56 Image quality
- pg. 152 Nikon Capture 2
- pg. 150 Nikon View 4
- pg. 140 The **Folder Designate** menu
- pg. 117 The **File No. Seq.** menu

### Custom Setting 29: File Number Sequence

When saving photographs, the camera assigns each image a file name consisting of "DSC\_" followed by a four-digit number from 0001 to 9999. Images are stored in folders with a name consisting of a three-digit folder number between 100 and 999, followed by "NCD1H" (for example, "100NCD1H"). Custom Setting 29 controls how the camera assigns folder and file numbers. File numbering can also be controlled using the **File No. Seq.** option in the shooting menu.

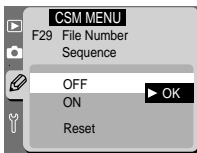

Option	No.	Description
<b>OFF</b> (default)	29-0	The camera does not store the last file name or folder number used. When a new file or folder is created, numbering starts from the lowest number available.
<b>ON</b>	29-1	When this option is selected, the camera assigns all subsequent folder and file numbers sequentially in ascending order, starting from the last numbers used. If the memory card is formatted or a new card inserted in the camera, folder and file numbering will continue from the last numbers used. This makes it easier to keep track of images and helps prevent files from being accidentally overwritten when folders are copied to a computer.
<b>Reset</b>		Sequential numbering begins again from the lowest number available in the current folder.



### File Numbering

If continuous file numbering is not selected, file numbering will begin from 0001 whenever the user creates a new folder from the playback **Folder Designate** menu. File numbering will also begin from 0001 whenever the camera creates a new folder automatically, whether or not continuous file numbering is selected. New folders are created automatically when:

- The number of images in the current folder reaches 999
- The current folder contains a file numbered 9999



## Custom Setting 30: PC Shooting Mode

When the camera is in PC mode, the mode dial can not be used to choose between single-frame and continuous modes. This setting determines the shooting mode when the camera is connected to a computer.

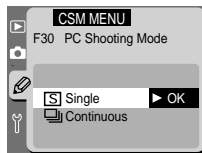

Option	No.	Description
<b>Single</b> (default)	<b>30-5</b>	Camera takes a single photograph each time the shutter-release button is pressed.
<b>Continuous</b>	<b>30-6</b>	Photographs are taken one after the other while the shutter-release button is held down.

## Custom Setting 31: ISO Boost

This setting is used to raise sensitivity (ISO equivalency) roughly one to two steps (1–2 EV) above the maximum setting, which is approximately equivalent to ISO 1600. This option is independent of the setting chosen with the ISO button or shooting menu. Sensitivity boost can be used to obtain higher shutter speeds at night-time sporting events, for example, or to prevent underexposure when photographing poorly-lit subjects. Note, however, that sensitivity boost increases the amount of “noise” (a mottling effect similar to the effects of grain in high-speed film) that appears in the final photograph.



Option	No.	Description
<b>OFF</b> (default)	<b>31-0</b>	Sensitivity boost can not be used.
<b>1 step over 1600</b>	<b>31-1</b>	Sensitivity raised roughly one step (1 EV) over ISO 1600 equivalent. Rear control panel shows <b>HI-1</b> .
<b>2 steps over 1600</b>	<b>31-2</b>	Sensitivity raised roughly two steps (2 EV) over ISO 1600 equivalent. Rear control panel shows <b>HI-2</b> .



**For more information on:**

pg. 148 Connecting the camera to a computer

pg. 62 Sensitivity (ISO equivalency)

### Custom Setting 32: Color Mode

Your Nikon digital camera offers you a choice of color modes for recording digital photographs. Choose a setting suited to your production work-flow and the task at hand. When opening photographs in an application that supports color management, select a color profile that matches the color setting in effect at the time the photograph was taken. Note that if you convert the image to a different color space when opening it, you will not achieve exactly the same colors as the original. If the image is converted to a color space with a narrower gamut, tonal discontinuities may be observed.

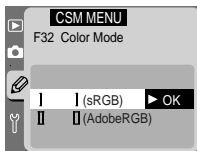

Option	No.	Description
<b>I (sRGB)</b> (default)	<b>32-0</b>	This setting is adapted to the sRGB color space, which reproduces colors as seen with little or no editing. It is particularly suited to human portrait subjects.
<b>II (Adobe RGB)</b>	<b>32-1</b>	Images recorded in this mode are adapted to the Adobe RGB color space. This color space is capable of expressing a wider range colors than the sRGB color space, making it the preferred choice in studio settings and commercial production workflows.

## Custom Setting 33: Hue Adjustment

Although the camera's sophisticated metering and white balance are capable of reproducing colors accurately under almost all lighting conditions, you may want to adjust hue to cope with unusual lighting conditions or to deliberately introduce a color cast into the image. This adjustment can be made using the color saturation setting. Values for color saturation range from 0 to 6, with 3 being the default value. Raising the value for color saturation above 3 will introduce a yellow cast, with the result that colors that appear red at a setting of 3 will become increasingly orange as the value is raised. Lowering color saturation below 3 will introduce a blue cast, with the result that colors that appear red at a setting of 3 will become increasingly purple as the value is lowered.

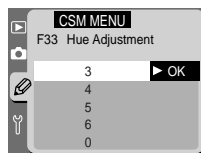

## Custom Setting 34: Disable Shutter if no CF Card

By default, the shutter release is disabled when no memory card is inserted in the camera. This option can be used to enable shutter release when no memory card is inserted. Note that when the camera is connected to a computer running Nikon Capture 2, photographs are recorded to the computer's hard disk rather than to the memory card, with the result that the shutter release will be enabled regardless of the option selected in Custom Setting 34.

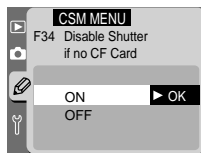

Option	No.	Description
<b>ON</b> (default)	34-0	Shutter-release button locks when no card is inserted in the camera.
<b>OFF</b>	34-1	Shutter-release button is enabled even when no card is inserted in the camera.



When the camera is connected to a computer in PC mode, the shutter can be released even if no memory card is present in the camera, regardless of the option chosen in Custom Setting 34.



**For more information on:**

**Custom Setting 35:Rear Control Panel Display**

This setting determines whether the display in the rear control panel indicates the current sensitivity (ISO equivalency) setting or the number of exposures remaining.

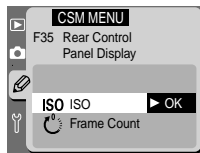

Option	No.	Description
<b>ISO</b> (default)	<b>35-0</b>	Rear control panel shows current sensitivity setting.
<b>Frame Count</b>	<b>35-1</b>	Rear control panel shows the number of exposures remaining. Sensitivity is displayed only while the ISO button is pressed.

## Restoring Default Settings (Two-Button Reset)

By pressing the **FUNC** and  buttons simultaneously, you can reset camera settings to their default values. Pressing the buttons together twice resets both camera settings and custom settings for the current settings bank.

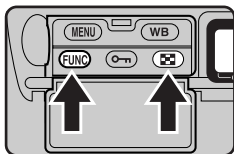

### Restoring Camera Settings to Default Values

To clear camera settings, hold the **FUNC** and  buttons down together for more than two seconds. The following settings will be restored to their default values:

Setting	Default	Setting	Default
Image quality	JPEG Normal	Flexible program	Off
Image type	Color	Shutter-speed lock	Off
Sensitivity	ISO 200 equivalent	Aperture lock	Off
White balance	Auto	Auto-exposure lock	Off
White balance adjustment	±0	Exposure compensation	±0.0
AF-area mode	Single Area AF	Auto bracketing	Off
Focus area	Center	Flash sync mode	Front-curtain sync
Exposure mode	Programmed auto		

### *Restoring Custom Settings to Default Values*

Default settings for the current settings bank can be restored by holding the **FUNC** and  buttons down together for more than two seconds. The **CUSTOM** indicator in the rear control panel will start to blink. Release both buttons while the indicator is blinking and then press both buttons again. All settings in the current settings bank, together with the camera settings listed above, will be reset to default values. Settings in other banks are not affected.

The pages that follow provide an index to the options available in the shooting, playback, and setup menus.

### The Playback Menu

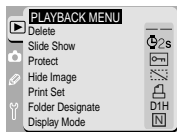

The playback menu, which can be accessed in all operating modes, contains the playback options shown opposite.



## Delete

Delete all or selected photos and cancel print orders. Individual images can also be deleted using the  button.

 pg. 130



## Slide Show

Automated playback.

 pg. 134



## Protect

Protect images from deletion. Individual images can also be protected using the  button.

 pg. 133



## Hide Image

Hide images during playback.

 pg. 136

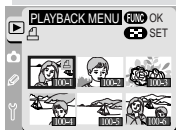

## Print Set

Create digital print-order files.

 pg. 138

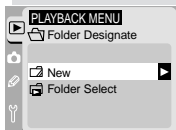

## Folder Designate

Create new folders; select folder from which photos will be played back.

 pg. 140



## Display Mode

Choose whether photos will be displayed with a histogram showing the distribution of tones in the image or with highlights indicated by a flashing border. This option can also be adjusted using Custom Setting 27.

 pg. 142



### The Shooting Menu

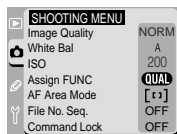

The shooting menu controls shooting settings in single-frame, continuous, self-timer, and PC modes. Many of the options in the shooting menu can also be accessed using the buttons and command dials.



## Image Quality

Choose image quality (compression ratio) and format (color and size). At an image quality of High, a further menu of file format options is available. This operation can also be performed using the **FUNC** button and command dials.



pg. 56

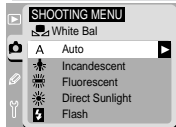

## White Bal

Set white balance according to the light source. White balance can also be adjusted using the **WB** button.



pg. 64

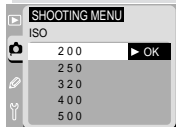

## ISO

Choose a sensitivity (ISO equivalency) setting. Sensitivity can also be adjusted using the ISO button and the main command dial.



pg. 62



## Assign FUNC

Select the function assigned to the **FUNC** button in shooting mode.



pg. 116

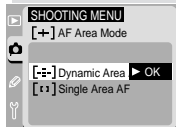

## AF Area Mode

Set the camera to focus on the subject in a single focus area (single-area AF) or to track the subject as it moves from one focus area to the next (dynamic AF). This operation can also be performed using the **FUNC** button and the main command dial.



pg. 74



## File No. Seq.

Control how the camera assigns file names to photographs. File-name assignment can also be controlled using Custom Setting 29 ( pg. 179).



pg. 117



## Command Lock

Lock shutter speed and/or aperture. This operation can also be performed using the **FUNC** button and command dials.



pg. 94

### The Setup Menu

The setup menu is used to adjust basic camera settings and perform such tasks as formatting memory cards.



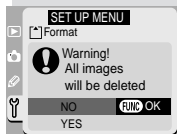

## Format

Format memory cards for use in your Nikon digital camera. This operation can also be performed using two  buttons.

 pg. 143



## Language

Choose the language in which menus and messages are displayed.

 pg. 28

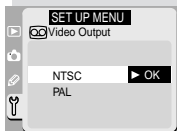



## Video Output

Select the standard used for video output when the camera is connected to a television or VCR.

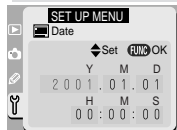
 pg. 147



## Date

Set the date and time. The date and time can also be set using the BKT and  buttons ( pg. 217).

 pg. 30

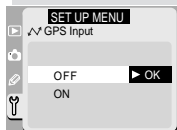

## GPS Input

Adjust serial-port settings for connection to a Global Positioning System (GPS) device.

 pg. 144



## LCD Brightness

Adjust monitor brightness.

 pg. 144



## Monitor Off

Specify how long the monitor will remain on when no operations are performed. This option can also be adjusted using Custom Setting 18.

 pg. 145



## TECHNICAL NOTES

- ***Caring for Your Camera***  
..... pp. 194–197
- ***Optional Accessories***  
..... pp. 198–207
- ***Troubleshooting*** ..... pp. 208–211
- ***Specifications***..... pp. 212–219
- ***Index***..... pp. 220–223

---

---

### About This Section

---

---

This section describes how to care for your Nikon digital camera to ensure that it remains in good working order; and explains what to do if the camera does not function as expected. It also lists the accessories available for your camera and details camera specifications.

## Replacing the Focusing Screen

Your Nikon digital camera is supplied with a type B BriteView focusing screen. A type E clear-matte Fresnel screen for cameras in the D1 series, with a grid suitable for tracing and architectural photography, is available for separate purchase.

To change focusing screens:

- 1 After turning the camera off, remove the lens (A). Using the tweezers supplied with the focusing screen, pull the focusing screen latch towards you (B). The screen holder will spring open.

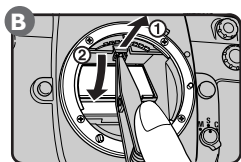
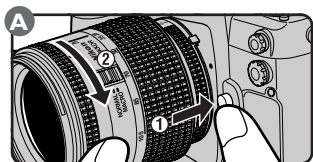

- 2 Remove the existing screen, using the tweezers supplied and being careful to handle the screen by the tab to avoid scratches (A). Using the tweezers to hold the screen by the tab, set the replacement screen in the holder (B). Push the front edge of the holder upward until it clicks into place (C).

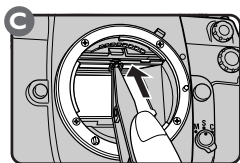
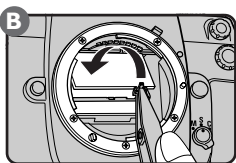
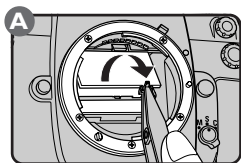

Do not touch the mirror or the surfaces of the focusing screens.



Use only focusing screens designated for use with cameras in the D1 series.

## Cleaning

When cleaning the camera body, lens, mirror, viewfinder, and monitor, follow the precautions listed in the table below.

<b>Camera Body</b>	Use a blower to remove dust and lint, then wipe gently with a soft, dry cloth. After using the camera at the beach or seaside, wipe off any sand or salt with a cloth lightly dampened with pure water and then dry thoroughly.
<b>Lens, Mirror, Viewfinder</b>	These elements are made of glass and are easily damaged. Remove dust and lint with a blower. If using an aerosol blower, keep the can vertical (tilting the can could result in liquid being sprayed on lens, mirror, or viewfinder). To remove fingerprints and other stains, apply a small amount of lens cleaner to a soft cloth and clean the lens with care.
<b>Monitor</b>	Remove dust and lint with a blower. To remove fingerprints and other stains, wipe the surface lightly with a soft cloth or chamois leather. Do not apply pressure, as this could result in damage or malfunction.

## Servicing Your Camera and Accessories

Your camera is a precision machine and requires regular servicing. We recommend that you have your camera inspected by your retailer or Nikon service representative once every one to two years, and that you have it serviced once every three to five years (note that fees are charged for these services). Frequent inspection and servicing are particularly recommended if you use your camera professionally. When having your camera inspected or serviced, we recommend that you bring any accessories regularly used with the camera, such as lenses and flash units.



Should the monitor break, care should be taken to avoid injury due to broken glass and to prevent liquid crystal touching the skin or entering the eyes or mouth.



In rare instances, static electricity from a brush or cloth may cause the control panels to brighten or darken. This does not indicate a malfunction; the display will shortly return to normal.



### Cleaning the low-pass filter

The charge-coupled device (CCD) that acts as the camera's picture element is fitted with a low-pass filter to prevent moiré. Although this filter prevents dirt from adhering directly to the CCD, under certain shooting conditions dirt or dust on the filter may appear in photographs. In this case it will be necessary to clean the filter:

### Determining Whether the Filter Requires Cleaning

The following two methods are available for determining whether the filter requires cleaning:

- 1 To ensure that the shutter is not damaged, this procedure requires that the camera be powered by an EH-4 AC adapter (available separately). Turn the camera off and connect the adapter.
- 2 Remove the lens and turn the camera on.
- 3 Press the **MENU** button and press the multi selector up or down to select the custom settings menu.
- 4 After pressing the multi selector to the right to enter the custom settings menu, press the multi selector up or down to highlight Custom Setting 8 (**Mirror Lock-up for CCD Cleaning**) and then press the multi selector to the right to display the menu of options shown at right.
- 5 Highlight **CCD Cleaning** and press the multi selector to the right. The mirror will be raised to the cleaning position and the shutter curtain will open, revealing the low-pass filter.
- 6 Holding the camera so that light falls on the low-pass filter, examine it for dirt or dust. Should you find a foreign object on the filter, clean it as described below. If there is no dirt on the filter, display the **Mirror Lock-up for CCD Cleaning** sub-menu as described in steps 3 and 4 and select the **OFF** option. The mirror will return to the down position and the shutter curtain will close.

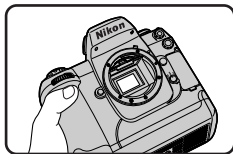
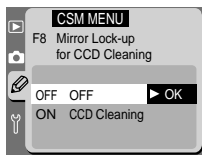
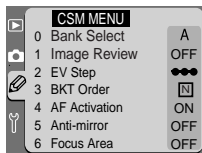

## Cleaning the Filter

The low-pass filter is extremely delicate and easily damaged. It is recommended that you have the filter cleaned by Nikon-authorized service personnel. Should you choose to ignore this warning and clean the filter yourself, follow the steps below.

**1** Raise the mirror as described in the first five steps of “Determining Whether the Filter Requires Cleaning.” Note that an EH-4 AC adapter (sold separately) is required for this operation; if no adapter is available, you will need to take the camera to a Nikon-authorized service center for cleaning.

**2** Remove dirt and dust from the filter with a blower. Do not use a blower-brush, as the bristles could damage the filter. If using an aerosol blower, hold the can upright to prevent liquid from falling on the filter. Dirt that can not be removed with a blower can only be removed by Nikon-authorized personnel. Under no circumstances should you touch or wipe the filter.

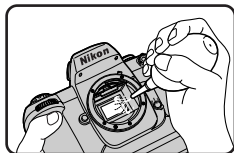

**3** Display the **Mirror Lock-up for CCD Cleaning** sub-menu as described above under steps 3 and 4 of “Determining Whether the Filter Requires Cleaning” and select the **OFF** option. The mirror will return to the down position and the shutter curtain will close.

**4** Turn the camera off and replace the lens or body cover, then unplug the AC adapter.

## Compatible Lenses

Nikon recommends CPU lenses for use in your Nikon digital camera. Type G or D lenses are particularly recommended due to the fact that it is only with lenses of these types that you will have access to the full range of shooting options available for your camera. The lenses that can be used with cameras in the D1 series are listed below.

Lens		Exposure mode			
		P	S	A	M
CPU lenses	Type G or D AF Nikkor; AF-S, AF-I Nikkor	✓	✓	✓	✓
	PC Micro Nikkor 85 mm F2.8D	—	—	—	✓ <sup>3</sup>
	AF-I Teleconverter <sup>5</sup>	✓	✓	✓	✓
	AF Nikkor other than type G or D (except lenses for F3AF)	✓	✓	✓	✓
	AI-P Nikkor	✓	✓	✓	✓
Non-CPU lenses	AI-type Nikkor	—	—	✓	✓
	AI-modified Nikkor	—	—	—	✓
	Reflex-Nikkor <sup>8</sup>	—	—	✓	✓
	PC-Nikkor <sup>8</sup>	—	—	✓ <sup>9</sup>	✓ <sup>10</sup>
	AI-type Teleconverter	—	—	✓	✓
	PB-6 Bellows Focusing Attachment <sup>12</sup>	—	—	✓ <sup>13</sup>	✓ <sup>13</sup>
Auto extension rings (PK 11A, 12, 13, PN-11)		—	—	✓	✓

1 With electronic range finder.

2 Metering area corresponds to selected focus area (📖 pg. 73).

3 The camera's exposure metering and flash control system do not work properly when shifting and/or tilting the lens, or when an aperture other than the maximum aperture is used.

4 Without shifting and/or tilting.

5 Compatible with all AF-S and AF-I Nikkor lenses except the AF-S 17–35 mm f/2.8D IF-ED and AF-S 28–70 mm f/2.8D IF-ED.

6 With maximum effective aperture of f/5.6 or faster.

7 With maximum aperture of f/5.6 or faster.

8 Some lenses can not be used (📖 pg. 200).

A variety of AF Nikkor lenses, including wide-angle, telephoto, zoom, micro, defocus image control (DC), and regular lenses with focal lengths of 16–600 mm, are currently available for use with cameras in the D1 series. Contact your retailer or local Nikon representative for details.

Focusing		Exposure metering mode		
Autofocus	Manual <sup>1</sup>	Matrix	Center-weighted	Spot
✓	✓	✓ (3D color)	✓	✓ <sup>2</sup>
—	✓ <sup>4</sup>	✓ <sup>3</sup> (3D color)	✓ <sup>3</sup>	✓ <sup>2,3</sup>
✓ <sup>6</sup>	✓ <sup>6</sup>	✓ (3D color)	✓	✓ <sup>2</sup>
✓	✓	✓ (Color)	✓	✓ <sup>2</sup>
—	✓ <sup>7</sup>	✓ (Color)	✓	✓
—	✓ <sup>7</sup>	—	✓	✓
—	✓ <sup>7</sup>	—	—	—
—	—	—	✓	✓
—	✓ <sup>4</sup>	—	✓ <sup>9</sup>	✓ <sup>9</sup>
—	✓ <sup>6</sup>	—	✓ <sup>11</sup>	✓ <sup>11</sup>
—	✓ <sup>6</sup>	—	✓	✓
—	✓ <sup>6</sup>	—	✓	✓

- 9 Exposure determined by presetting lens aperture. AE lock must also be performed before shifting.
- 10 Exposure determined by presetting lens aperture. Exposure must also be determined before shifting.
- 11 Exposure compensation required with some lenses (refer to instruction manual provided with teleconverter).
- 12 Auto Extension Ring PK-11A, 12, or 13 required.
- 13 Exposure determined by presetting lens aperture on bellows. Release shutter after exposure metering.

### Identifying Type G or D Nikkor Lenses with Built-in CPUs

CPU lenses (A) can be identified by the CPU contacts. In addition, type G AF-Nikkor lenses have a “G” mark on the lens (B), while type D AF-Nikkor lenses are indicated by a “D” mark (C).

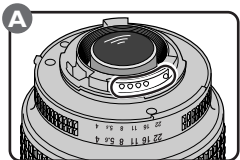

Nikkor lens with built-in CPU (CPU lens)

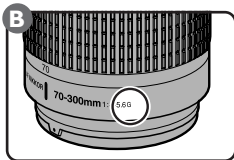

Type G AF-Nikkor lens

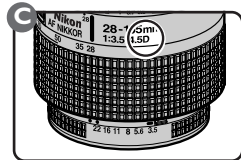

Type D AF-Nikkor lens

Type G lenses are not equipped with an aperture ring. Unlike other lens types, there is no need to lock the aperture ring at the minimum aperture setting (maximum  $f$ -number) when using type G lenses with this camera.



### Incompatible Lenses

The following non-CPU lenses can NOT be used with cameras in the D1 series:

- TC-16AS AF Teleconverter
- Non-AI lenses
- Lenses that require the AU-1 focusing unit (400 mm  $f/4.5$ , 600 mm  $f/5.6$ , 800 mm  $f/8$ , 1200 mm  $f/11$ )
- Fisheye (6 mm  $f/5.6$ , 8 mm  $f/8$ , OP10 mm  $f/5.6$ )
- 21 mm  $f/4$  (old type)
- K2 ring
- ED 180–600 mm  $f/8$  (serial numbers 174041–174180)
- ED 360–1200 mm  $f/11$  (serial numbers 174031–174127)
- 200–600 mm  $f/9.5$  (serial numbers 280001–300490)
- Lenses for the F3AF (80 mm  $f/2.8$ , 200 mm  $f/3.5$ , TC-16S Teleconverter)
- PC 28 mm  $f/4$  (serial number 180900 or earlier)
- PC 35 mm  $f/2.8$  (serial numbers 851001–906200)
- PC 35 mm  $f/3.5$  (old type)
- 1000 mm  $f/6.3$  Reflex (old type)
- 1000 mm  $f/11$  Reflex (serial numbers 142361–143000)
- 2000 mm  $f/11$  Reflex (serial numbers 200111–200310)

### Lens Focal Length and Picture Angle

The size of the area exposed with a 35-mm camera is  $24 \times 36$  mm. In the case of the D1H, however, it is  $15.6 \times 23.7$  mm. Consequently, the picture angle of photographs taken with the D1H will differ from the picture angle for 35-mm cameras, even when the focal length of the lens and the distance to the subject are the same.

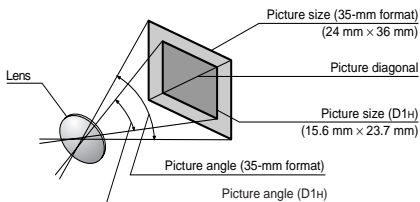

The diagonal picture angle of a 35-mm camera is roughly 1.5 times that of the D1H. Consequently when a lens of a given focal length is attached to the D1H, the corresponding focal length in 35mm format at the D1H's picture angle can be calculated by multiplying the focal length of the lens by 1.5. The following chart shows some examples:

Picture angle	Approximate Focal length (mm) in 35-mm format (modified for picture angle)							
	35-mm film camera	17	20	24	28	35	50	60
D1H	25.5	30	36	42	52.5	75	90	127.5

Picture angle	Approximate Focal length (mm) in 35-mm format (modified for picture angle)							
	35-mm film camera	105	135	180	200	300	400	500
D1H	157.5	202.5	270	300	450	600	750	900



### Using a Non-CPU Lens

When using a non-CPU lens, choose center-weighted or spot metering and set the exposure mode to aperture-priority auto or manual. Even if you choose programmed auto or shutter-priority auto, the camera will automatically select aperture-priority auto with center-weighted metering, and the exposure mode indicator (**P** or **S**) in the control panel on top of the camera will blink to show that aperture-priority auto is in effect (the viewfinder display will show **A**). Regardless of the exposure mode selected, aperture can only be set using the lens aperture ring; the sub-command dial can not be used to set aperture. The aperture indicators in the viewfinder and in the control panel on top of the camera will show **F--**.

### Other Accessories

At the time of writing, the following accessories were available for your Nikon digital camera. Contact your retailer or local Nikon representative for details.

#### *EN-4 Rechargeable Battery Pack*

The EN-4 is a rechargeable nickel-metal hydride (Ni-MH) battery pack designed exclusively for use in D1-series cameras.

#### *MH-16 Quick-Charger*

The MH-16 can be used to recharge EN-4 battery packs.

#### *MH-17 Quick-Charger*

The MH-17, which plugs into vehicle cigarette lighters, can be used to recharge EN-4 battery packs while on the road.

#### *EH-4 AC Adapter*

The EH-4 can be used with AC power sources of 100–120 V or 220–240 V and 50–60 Hz. Separate power cables are available for use in North America, the United Kingdom, Europe, Australia, and Japan.

#### *Focusing Screens*

In addition to the type B BriteView focusing screen supplied with your camera, you can use the type E clear matte Fresnel focusing screen for cameras in the D1 series. The type E screen is etched with a grid (see right), making it suitable for copying and architectural photography. Best results are achieved with PC-Nikkor lenses. A type B BriteView focusing screen is supplied with all cameras in the D1 series.

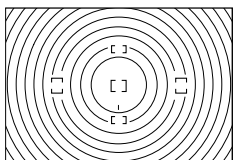

Type B focusing screen

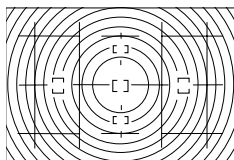

Type E focusing screen

### Buying Camera Accessories

Your camera is optimized for use with Nikon-brand accessories. Accessories sold by other manufacturers may not be made to Nikon specifications and could damage your camera. Nikon can not guarantee performance when the camera is used with non-Nikon accessories.

### **EC-CF CompactFlash Memory Cards**

These cards can be inserted in the D1H and used to record photographs. Their small size makes them extremely portable.

#### **Compatible CompactFlash and Microdrive cards**

Nikon EC-CF CompactFlash memory cards are available for cameras in the D1 series. In addition, the CompactFlash memory cards and microdrives listed below have been tested and approved for use in the D1H.

- SanDisk SDCFB-16, SDCFB-32, SDCFB-48, SDCFB-64, SDCFB-96, SDCFB-128 CompactFlash memory cards
- Lexar Media 10x USB 128 MB and 160 MB; 8x USB 8 MB, 16 MB, 32 MB, 48 MB, 64 MB, and 80 MB; 4x USB 8 MB, 16 MB, 32 MB, 48 MB, 64 MB, and 80 MB CompactFlash memory cards
- IBM DSCM-10512 and DSCM-11000 microdrives

Contact the manufacturer for more information on the functions of and recommended uses for the above memory cards.

### **EC-ADI PC Card Adapter**

Using the PC card adapter, CompactFlash memory cards can be read by computers equipped with PCMCIA card slots configured for ATA memory cards.

---

## **Memory Cards**

---

- Memory cards may be hot after use. Observe due caution when removing cards from the camera.
  - Format memory cards before first use.
  - Do not remove memory cards from the camera during formatting. Failure to observe this precaution could render the card unfit for use.
  - Do not remove the memory card from the camera, turn the camera off, remove the batteries, or unplug the AC adapter while data are being recorded to, or deleted from, the memory card or while data are being transferred to a computer. Failure to observe this precaution could result in loss of data or in damage to the camera or card.
  - Do not touch the terminals with your fingers or metal objects.
  - Do not apply force to the card cover. Failure to observe this precaution could result in damage to the card.
  - Do not bend, drop, or subject to strong physical shocks.
  - Do not expose to water, high levels of humidity, or direct sunlight.
-



### **DK-14 Antifog Finder Eyepieces**

These viewfinder eyepieces prevent fogging in humid or cold conditions.

### **DK-2 Rubber Eye Cup**

Prevents eye fatigue by making it easier to see the image in the viewfinder.

### **Diopter-Adjustment Viewfinder Lenses**

To accommodate individual differences in vision, nine types of viewfinder lenses are available with diopters of  $-3$ ,  $-2$ ,  $0$ ,  $+1$ , and  $+2$ .

### **DR-4 Right-Angle Viewing Attachment/DK-7 Eyepiece Adapter**

The DR-4 attaches at a right angle to the viewfinder eyepiece, allowing you to view the image in the viewfinder from above. The DK-7 is used when attaching the DR-3 Right-Angle Viewing Attachment or the DG-2 Eyepiece Magnifier to cameras in the D1 series.

### **Filters**

Nikon filters can be divided into three types: screw-in, drop-in and rear-interchange. With the exception of the R60, exposure compensation need not be adjusted when a Nikon filter is attached (in the case of the R60, set exposure compensation to  $+1$ ). Filters manufactured by other makers may interfere with autofocus or electronic range-finding.

Cameras in the D1 series can not be used with Polar polarizing filters. Use the C-PL circular polarizing filter instead.

If you are using a filter to protect the lens, it is recommended that you use an NC or L37C filter.

When shooting with a filter attached, moiré may be observed when shooting a subject against a bright light, or when a strong light source is in the frame. In these conditions, it is recommended that you remove the filter before shooting.

### **Nikon SB-28DX Speedlight**

This Speedlight has a guide number of 50 (manual mode, 35-mm zoom-head position, ISO 200 m, 20 °C/68 °F) and is powered with four alkaline batteries (other power sources for the SB-28DX include the SD-6, SD-7, SD-8A, and SK-6 power bracket—all available separately). When attached to cameras in the D1 series, it supports D-3D multi-sensor balanced fill-flash for natural, balanced light, even when the scene contains highly reflective objects or the background is very far from the camera. The SB-28DX is equipped with an AF-Assist Illuminator, allowing autofocus to be used when shooting very dark subjects. It also boasts auto power zoom that changes the flash angle according to the focal length of the lens, and supports Slow Sync, Rear-Curtain Sync, non-TTL auto, Manual, Repeating, and FP High-Speed Sync flash modes.

### **✓ Speedlight Accessories for the SB-28DX**

When using the following Speedlight accessories with the SB-28DX, be aware that these accessories exist in two varieties (old and new), each with a different type of connector:

- SD-6 battery stack/SD-7 C-cell battery pack  
The SC-16 power cable supplied with older models of these products can not be connected to the SB-28DX. The SC-16A power cable supplied with newer models is also available for separate purchase, and can be used to connect old-model SD-6 and SD-7 power sources to the SB-28DX.
- SK-6 power bracket  
The connector on old-model SK-6 power-brackets can not be used with the SB-28DX. Owners of old-model SK-6 power-brackets are advised to contact the Nikon service representative in their area.
- SD-8 power-assist pack  
The SD-8 can not be used with the SB-28DX. Owners of the SD-8 are advised to contact the Nikon service representative in their area. Note that the new model, the SD-8A, can be used with the SB-28DX.

### Nikon SB-50DX Speedlight

This Speedlight has a guide number of 31 (manual mode, 35-mm zoom-head position, ISO 200 m, 20°C/68 °F) and is powered with two CR123A or DL123A type 3V lithium batteries. When attached to cameras in the D1 series, it supports D-3D multi-sensor balanced fill-flash for natural, balanced light, even when the scene contains highly reflective objects or the background is very far from the camera. The SB-50DX is equipped with an AF-Assist Illuminator, allowing autofocus to be used when shooting very dark subjects. It also boasts auto power zoom that changes the flash angle according to the focal length of the lens, and supports Slow Sync, Rear-Curtain Sync, Manual flash modes. It offers a tilt position of -18°, allowing the flash to be used at ranges as close as 30 cm (11.8").

### Accessories for the Remote Terminal

Your Nikon digital camera is equipped with a ten-pin remote terminal for remote-control photography, automatic photography, and connection to other devices. The terminal is provided with a cap, which protects the contacts when the terminal is not in use. The following accessories can be connected:

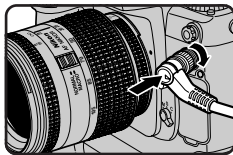

Accessory	Description	Length (approx.)
<b>MC-20 Remote Cord</b>	Remote shutter release; can be used to reduce camera shake. It is equipped with time-exposure and timer features, emitting a beep once a second while the shutter is open.	80 cm/ 2.6'
<b>MC-21 Extension Cord</b>	Can be connected to the MC-20, MC-22, MC-25, or MC-30.	3 m/9.8'
<b>MC-22 Remote Cord</b>	Remote shutter release with blue, yellow, and black terminals for connection to a remote shutter-triggering device, making it possible to control the camera via sound or electronic signals.	1 m/3.3'
<b>MC-23 Connecting Cord</b>	Allows simultaneous operation of two D1 hs.	40 cm/ 1.3'





Accessory	Description	Length (approx.)
<b>MC-25 Adapter Cord</b>	Ten-pin to two-pin adapter cord for connection to the MW-2 Radio Control Set, the MT-2 Intervalometer, the ML-2 Modulite Control Set, and other devices with two-pin terminals.	20 cm/ 0.7'
<b>MC-30 Remote Cord</b>	Remote shutter release; can be used to reduce camera shake. Can be used to lock the shutter-release button during a time exposure.	80 cm/ 2.6'
<b>ML-2 Modulite Remote Control Set</b>	Allows infrared remote control with a range of up to 100 m (328'). Remote control over greater distances can be achieved with multiple units. Requires MC-25 Adapter Cord.	—
<b>ML-3 Modulite Remote Control Set</b>	Allows infrared remote control with a range of up to 8 m (26.2').	—



### Software

Two software packages are available for the D1H: Nikon View 4, which allows the contents of the camera's memory to be viewed when the camera is connected to the computer via its IEEE 1394 interface, and Nikon Capture 2, which offers remote control and image enhancement features. Both packages are available in Windows and Macintosh versions.







This section lists the indicators and messages that appear in the viewfinder, control panels, and monitor when there is a problem with the camera. Consult the list below before contacting your retailer or Nikon representative.

## Control Panel and Viewfinder Indicators

Indicator		Problem	Solution	
Control panel	Viewfinder			
<b>FE E</b> (blinking)	<b>FE E</b> (blinking)	Lens aperture ring is not set to minimum aperture	Set ring to minimum aperture (largest f/-number)	pg. 25
	†	Low battery	Ready fully-charged spare battery	pg. 23
	††	Battery exhausted	Replace battery	pg. 23
<b>F - -</b>	<b>F - -</b>	Lens not attached, or attached lens not Nikkor lens with built-in CPU	Use CPU Nikkor lens (IX-Nikkor excepted), or set exposure mode to <b>A</b> or <b>M</b> and use lens aperture ring to set aperture	pg. 24, pg. 88, pg. 90, pg. 198
	 (blinking)	Camera can not focus using autofocus	Focus manually	pg. 81
<b>HI</b>	<b>HI</b>	Subject too bright; photo will be overexposed	In exposure mode: <b>P</b> —use ND filter <b>S</b> —increase shutter speed; if indicator persists, use ND filter <b>A</b> —choose a smaller aperture (higher f/-number); if indicator persists, use ND filter	pg. 86, pg. 88





† Indicators in viewfinder are only visible when a button is pressed. In addition, the metering-method indicator (  ,  ,  ) flashes to warn that the battery is low.

†† Indicators in viewfinder and rear control panel turn off to save power.

Indicator		Problem	Solution	
Control panel	Viewfinder			
		Subject too dark; photo will be underexposed	In exposure mode: <b>P</b> —use flash <b>S</b> —lower shutter speed; if indicator persists, use flash <b>A</b> —choose a larger aperture (lower f/-number); if indicator persists, use flash	pg. 86, pg. 88
		Shutter speed of bulb (long time-exposure) selected in shutter-priority auto	Choose another shutter speed or switch to manual exposure	pg. 86, pg. 90
<b>P</b> or <b>S</b> (blinking)	<b>A</b>	Exposure mode <b>P</b> or <b>S</b> selected and either: <ul style="list-style-type: none"> <li>• no lens in place, or</li> <li>• non-CPU lens in place</li> </ul>	Use CPU Nikkor lens or select exposure mode <b>A</b> or <b>M</b>	pg. 24, pg. 88, pg. 90, pg. 198
Shutter speed blinks	<b>500</b>	Shutter speed faster than lens sync speed (exposure mode <b>S</b> and <b>M</b> )	Shutter speed automatically set to $\frac{1}{500}$ s	pg. 114
		If indicator blinks for 3 s after flash fires, photo may be underexposed	Check photo in monitor; if underexposed, adjust exposure and try again	pg. 115
<b>Err</b> (blinking)	<b>Err</b> (blinking)	Camera malfunction	Release shutter. If indicator persists or appears frequently, consult with Nikon-authorized service representative	—
		Flash does not support red-eye reduction and flash-sync mode is either: <ul style="list-style-type: none"> <li>• red-eye reduction, or</li> <li>• slow sync with red-eye reduction</li> </ul>	Choose different sync mode or use flash that supports red-eye reduction	pg. 110, pg. 112

## Monitor Error Messages

Problems that occur during playback are indicated by messages that appear superimposed on the image in the monitor. An indicator may also appear in the control-panel display on top of the camera.

Message	Control panel	Problem	Solution	
No card present		Camera can not detect memory card	Turn camera off and confirm that card is correctly inserted	pg. 26
This card cannot be used		Camera can not access memory card, or card is not correctly formatted	Replace memory card with Nikon-approved card	pg. 203
Card is not formatted		Memory card has not been formatted for use in camera	Format memory card	pg. 143
Out of memory Card is full		Card is full, or number of files has exceeded maximum that can be handled by camera or all file numbers have been used	Delete photos or choose a lower image-quality setting or smaller image size or replace memory card	pg. 26, pp. 56–61, pp. 129–131
No images in current folder		<ul style="list-style-type: none"> <li>The memory card contains no images</li> <li>Folder selected for playback contains no images</li> </ul>	<ul style="list-style-type: none"> <li>Insert a memory card containing photographs</li> <li>No images can be played back until folder containing images is selected from playback <b>Folder Designate</b> menu</li> </ul>	pg. 26, pg. 140

Message	Control panel	Problem	Solution	
All images are hidden		All photos in current folder have been hidden	No images can be played back until <b>Hide Image</b> command has been used to allow at least one image to be displayed	pg. 136
File does not contain image data		<ul style="list-style-type: none"> <li>File format no longer conforms to DCF standard because image has been edited in an imaging application or otherwise modifying using a computer</li> <li>File corrupted</li> </ul>	When saving images after editing in a computer application, do not overwrite original file on memory card	pp. 148–154

**A Note on Electronically Controlled Cameras**

In extremely rare instances, unusual characters may appear in the control panels and the camera may stop functioning. In most cases, this phenomenon is caused by a strong external static charge. Turn the camera off, remove and replace the battery pack, and turn the camera on again.



# Specifications

<b>Type</b>	Single-lens reflex digital camera with interchangeable lenses		
<b>Operating</b>			
<b>Temperature</b>	0 – 40 °C (32 – 104 °F)		
<b>Humidity</b>	Less than 85% (no condensation)		
<b>Image sensor</b>	23.7 × 15.6 mm, 12-bit RGB CCD with 2.74 million pixels, effective pixel count 2.66 million pixels (2,012 × 1,324 pixels)		
<b>Image size</b>	2,000 × 1,312 pixels		
<b>Sensitivity</b>	200 – 1600 (ISO equivalent) in steps of 1/3, 1/2, or 1 EV		
<b>Storage</b>			
<b>Compression</b>	<ul style="list-style-type: none"> <li>• HI image quality: uncompressed YCbCr-TIFF (8-bit), RGB-TIFF (8-bit), or RAW data (12-bit); compressed RAW data (12-bit, lossless compression algorithm compresses data approximately 50% – 60%)</li> <li>• FINE, NORMAL, or BASIC image quality: JPEG baseline-compliant (approximate compression ratios 1:4, 1:8, 1:16 respectively)</li> </ul>		
<b>File system</b>	Design Rule for Camera File Systems, Digital Print-Order Format (DPOF) compliant		
<b>Media</b>	Type I/II CompactFlash cards; microdrives (512 MB, 1 GB)		
<b>Approximate capacity (96 MB media)</b>	High/RAW (uncompressed)	23 JPEG Fine (1 : 4)	66
	High/YCbCr-TIFF	17 JPEG Normal (1 : 8)	132
	High/RGB-TIFF	12 JPEG Basic (1 : 16)	265
<b>Operating modes</b>	<ul style="list-style-type: none"> <li>S Single frame, image-preview mode available</li> <li>C Continuous, approx. 5 fps, max. 40 consecutive shots</li> <li>☺ Self-timer mode; delay can be specified by user</li> <li>PLAY Playback mode with playback menu</li> <li>PC PC mode; data-transfer to computer</li> </ul>		
<b>White balance</b>	<ul style="list-style-type: none"> <li>• Auto (TTL control with 1,005-pixel CCD)</li> <li>• Six manual modes with fine tuning</li> <li>• Preset</li> </ul>		
<b>Playback</b>	Single-frame playback, thumbnail playback (4 or 9 images), slideshow, histogram, and highlight point display		
<b>Image deletion</b>	Card format, delete all images, delete selected images		

<b>Video output</b>	Can be selected from NTSC or PAL
<b>External interface</b>	IEEE 1394 (designed for speeds of up to 400 Mbps); RS-232C connection for GPS unit (GPS units not available from Nikon)
<b>Compatible lenses</b>	
<b>Type G or D AF Nikkor</b>	All camera functions supported
<b>Other type G or D Nikkor</b>	All camera functions except autofocus supported
<b>Other AF Nikkor</b>	All camera functions except 3D color matrix metering and 3D multi-sensor balanced fill-flash for the D1 series supported
<b>AI-P Nikkor</b>	All camera functions except 3D color matrix metering, 3D multi-sensor balanced fill-flash for the D1 series, and autofocus supported
<b>Other</b>	Other lenses can be used in aperture-priority or manual mode with center-weighted or spot metering; electronic range-finder can be used with lenses with a maximum aperture of f/5.6 or faster.
<b>Lens mount</b>	Nikon F mount (with AF coupling and AF contacts)
<b>Picture angle</b>	Equivalent in 35 mm (135) format is approximately 1.5 times lens focal length
<b>Viewfinder</b>	
<b>Type</b>	Optical fixed eye-level pentaprism with diopter adjustment of $-3$ to $+1$ $m^{-1}$ , equipped with eyepiece shutter
<b>Eyepoint</b>	22 mm (at $-1.0$ $m^{-1}$ )
<b>Focusing screen</b>	Type B BriteView clear matte screen Mark III; optional type E screen for D1 series cameras (with grid) can also be used
<b>Frame coverage</b>	Vertical and horizontal frame coverage approximately 96% of lens
<b>Magnification</b>	$0.8 \times$ with 50-mm lens set to infinity and $-1.0$ $m^{-1}$
<b>Reflex mirror</b>	Quick-return
<b>Lens aperture</b>	Instant return with depth-of-field preview

\* Unless otherwise stated, all figures are for a camera with a fully-charged battery operated at an ambient temperature of 20°C (68°F).

## Specifications (continued)

<b>Autofocus</b>	TTL phase detection by means of Nikon Multi-CAM1300 auto-focus module; detection range -1 to 19 EV (ISO 100 at room temperature)
<b>Lens servo</b>	Instant Single-servo AF (S), Continuous-servo AF (C), manual (M); focus tracking automatically activated according to subject status in single-servo and continuous-servo AF
<b>Focus area</b>	Focus area can be selected from five focus areas
<b>AF-area mode</b>	Single-area AF, Dynamic AF (supports closest subject priority)
<b>Focus lock</b>	Focus can be locked using the AE/AF lock button or, in single-servo AF, by pressing the shutter-release button halfway
<b>Exposure metering system</b>	TTL full-aperture exposure metering system with three metering modes
<b>3D color matrix</b>	3D color matrix metering using 1,005-pixel CCD supported when type G or D Nikkor lens is attached; with other lenses, color matrix metering using 1,005-pixel CCD is supported
<b>Center-weighted</b>	Greatest weight (75% of total) given to a circle in the center of the frame 8 mm in diameter
<b>Spot</b>	Exposure determined by 4-mm circle in center of frame (approximately 2% of frame); when a CPU Nikkor lens is attached, any of the five focus areas can be used for spot metering
<b>Exposure range</b>	At ISO 100, room temperature, and with f/1.4 lens: 0 – 20 EV (center-weighted or 3D color matrix metering) or 2 – 20 EV (spot metering)
<b>Exposure meter coupling</b>	Combined CPU and AI
<b>Exposure modes</b>	<b>P</b> Programmed auto with flexible program <b>S</b> Shutter-priority auto <b>A</b> Aperture-priority auto <b>M</b> Manual (exposure adjustable in steps of $1/2$ or $1/3$ EV)
<b>Exposure compensation</b>	-5 to +5 EV in increments of $1/3$ EV; exposure compensation indicator appears in viewfinder and top control panel
<b>Auto-exposure lock</b>	Locked at detected value when AE/AF lock button is pressed
<b>Auto bracketing</b>	2 – 3 exposures compensated in steps of $1/3$ , $1/2$ , or 1 EV

<b>Shutter</b>	Combined electronic (CCD) and mechanical shutter
<b>Speed</b>	30– $\frac{1}{16,000}$ sec. ( $\frac{1}{3}$ increments), long time-exposure ( <b>bulb</b> )
<b>Flash</b>	
<b>Sync contact</b>	X-contact only; flash synchronization at speeds of up to $\frac{1}{500}$ s
<b>Flash control</b>	<ul style="list-style-type: none"> <li>• Automatic balanced fill-flash controlled by five-segment TTL multi-sensor with single-component IC               <ul style="list-style-type: none"> <li>- 3D multi-sensor balanced fill-flash for D1 series (SB-28DX or SB-50DX with type G or D Nikkor lens)</li> <li>- Multi-sensor balanced fill-flash (SB-28DX or SB-50DX with AI-P Nikkor or Nikkor lens of a type other than type G or D)</li> </ul> </li> <li>• Auto-aperture (AA) flash (SB-28DX with CPU Nikkor lens)</li> <li>• Non-TTL auto flash (with SB-28DX, SB-50DX, SB-28, SB-27, SB-22s, and other Speedlights)</li> </ul>
<b>Flash sync modes</b>	Front curtain (normal) sync, red-eye reduction, red-eye reduction with slow sync, slow sync, rear curtain
<b>Flash-ready light</b>	Lights when SB-28DX, SB-50DX, SB-28, SB-27, or SB-22s is fully charged; blinks for three seconds after being fired at full output
<b>Accessory shoe</b>	Standard ISO hot-shoe contact with safety lock
<b>Sync terminal</b>	Standard JIS terminal with locking screw
<b>Self-timer</b>	Electronically controlled timer, duration 2–20 seconds
<b>Depth-of-field preview button</b>	Lens aperture stopped down when pressed
<b>Remote control</b>	Remote control via 10-pin remote terminal or IEEE 1394 interface (designed for speeds of up to 400 Mbps)
<b>Monitor</b>	2", 130,000-dot, low-temperature polysilicon TFT LCD with adjustable white LED backlight and brightness adjustment
<b>Power source</b>	EN-4 Ni-MH Battery Pack, 7.2 V DC (can be recharged with optional MH-17, MH-16 or MH-15 Quick Chargers); EH-4AC adapter (sold separately), 100 – 240 V AC
<b>Tripod socket</b>	$\frac{1}{4}$ " (JIS)
<b>Dimensions (W × H × D)</b>	Approximately 157 × 153 × 85 mm (6.2" × 6.1" × 3.4")
<b>Weight</b>	Approximately 1.1 kg (2.5 lbs) excluding battery



The following can reduce battery life:

- Using the monitor
- Keeping the shutter-release button pressed halfway
- Repeated autofocus operations
- Taking photographs at an image quality of High
- Slow shutter speeds

To ensure that you get the most from EN-4 rechargeable batteries:

To ensure that you get the most from EN-4 rechargeable batteries:

- Keep the battery contacts clean. Soiled battery contacts can reduce battery performance.
- Use batteries immediately after charging. Batteries will lose their charge if left unused.
- “Memory” effects can result in reduced battery performance. Should this occur, use the “refresh” button on the battery charger to discharge and recharge the battery.

\* Nikon reserves the right to change the specifications of the hardware and software described in these manuals at anytime without prior notice. Nikon will not be held liable for damages resulting from any mistakes which may be contained in this manual.

## LCD Illuminators



The LCD illuminators (control panel backlights) will dim gradually over time. This is normal; if desired, the illuminator can be replaced for a fee by a Nikon-authorized technician.

## Frame Count



The frame number shown in the control panel on top of the camera corresponds to the number of photographs in the current folder, and returns to one when a new folder is created. New folders are created when:

- The number of photographs in the current folder reaches the maximum of 999
- File numbering reaches 9999 in sequential-numbering mode
- A new folder is created using the **New** option in the playback **Folder Designate** menu

## Viewing the Time and Date

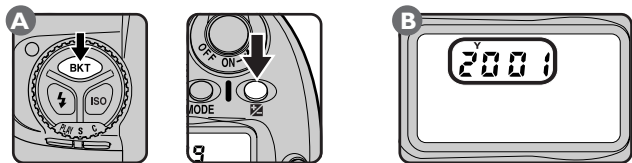
When the BKT and  buttons are pressed simultaneously (A), the year will be shown in the control panel on top of the camera (B). Press the  button once to display the month and day, and a second time to view the hour and minute. Pressing the button a third time will clear the time and date from the display.



To set the time and date, hold the BKT and  buttons down together for more than two seconds. The year indicator in the control panel will flash. Use the main command dial to set the year, and then press the  button to view and set the month. Repeat this process to set the hour and minute. To save changes to the time and date and return to normal operation, press the  button while the minute is displayed. To exit without saving changes, press the shutter-release button halfway. If no operations are performed for three minutes, any changes will be saved automatically, clearing the time and date from the display.



## Fine-Tuning White Balance

The color temperatures associated with fine adjustments to white balance at each setting are shown in the following table.

Adjustment	Approximate color temperature		
	Incandescent	Fluorescent*	Direct sunlight**
+3	2,700 K	2,700 K	4,800 K
+2	2,800 K	3,000 K	4,900 K
+1	2,900 K	3,700 K	5,000 K
±0	3,000 K	4,200 K	5,200 K
-1	3,100 K	5,000 K	5,300 K
-2	3,150 K	6,500 K	5,400 K
-3	3,250 K	7,200 K	5,600 K

\* Fluorescent white balance can be fine-tuned to accommodate a wide variety of artificial lighting, from stadium lighting with low color temperatures to mercury-vapor lighting with high color temperatures. Users of the D1 should note that the color temperatures that result when fluorescent white-balance is fine tuned differ widely from the values used in the D1H.

\*\* daylight

Approximate color temperature			Adjustment
Flash	Cloudy**	Shade**	
4,800 K	5,400 K	6,700 K	+3
5,000 K	5,600 K	7,100 K	+2
5,200 K	5,800 K	7,500 K	+1
5,400 K	6,000 K	8,000 K	±0
5,600 K	6,200 K	8,400 K	-1
5,800 K	6,400 K	8,800 K	-2
6,000K	6,600 K	9,200 K	-3



**Symbols**

- 3D color matrix metering. See Metering  
 3D multi-sensor balanced fill-flash for digital SLR. See Flash photography

**A**

- A (Aperture-priority auto exposure mode). See Exposure mode  
 A (Auto white balance). See White balance  
 AC adapter ..... 202  
 Accessories, optional ..... 198-207  
 Accessory shoe ..... 109  
 AF area mode ..... 74-77  
   dynamic AF ..... 74-77  
   single area AF ..... 74-77  
 AF lock. See Focus lock  
 Anti-mirror-shock mode ..... 163  
 Aperture ..... 88-91  
   lock ..... 95  
   maximum ..... 88  
   minimum ..... 25, 88, 200  
 Aperture-priority auto exposure mode.  
   See Exposure mode  
 Auto bracketing ..... 100-102  
 Auto exposure lock ..... 96-97  
 Autofocus ..... 70-80  
 Autofocus assist illuminator  
   ..... 114, 205, 206  
 Auto meter off delay ..... 168  
 Auto Off ..... 145

**B**

- Basic. See Image quality  
 Battery ..... vi-vii, 22-23, 202  
   battery indicator ..... 23, 208  
   clock ..... 31  
   installing ..... 22-23  
 Body cap ..... 25  
 Bulb ..... 90

**C**

- C (continuous servo autofocus). See Autofocus  
 C (continuous shooting mode). See Continuous shooting mode  
 Card slot ..... 26-27  
 Center-weighted fill-flash for digital SLR.  
   See Flash photography  
 Center-weighted metering. See Metering  
 Clock calendar ..... 30-31, 217  
 Closest subject priority ..... 76-77  
 Color mode ..... 181  
 Color temperature. See White balance  
 Continuous servo AF. See Focus mode  
 Continuous shooting mode  
   ..... 13, 52, 120-121  
 Custom settings ..... 156-185  
   Bank A, B, C, D ..... 156-157, 160  
   menu ..... 17, 160-183  
   resetting to default values ..... 184-185

**D**

- Data transfer. See PC mode  
 Date and time. See Clock calendar  
 DCF. See Design Rule for Camera File Systems  
 Delete ..... 130-131, 187  
 Deleting photographs ..... 50, 129-131  
 Depth of field ..... 88, 106  
 Depth-of-field preview ..... 106  
 Design Rule for Camera File Systems  
   ..... 141  
 Digital Print Order Format ..... 139  
 Display Mode ..... 124, 142  
 Distance information ..... 83, 108  
 Diopter adjustment. See Viewfinder diopter  
 DPOF. See Digital Print Order Format

- E**  
 EH-4 AC adapter. See AC adapter  
 Electronic analog exposure display ..... 92  
 Electronic range finder ..... 45, 81  
 EN-4 NiMH battery pack. See Battery  
 Exposure compensation ..... 98-99  
 Exposure mode ..... 42, 84-95  
   aperture priority auto ..... 88-89  
   manual ..... 90-93  
   programmed auto ..... 42, 84-85  
   shutter-priority auto ..... 86-87
- F**  
 Fine. See Image quality  
 Flash bracketing ..... 100, 166  
 Flash photography ..... 108-115  
   flash sync mode ..... 110-111  
   front-curtain sync ..... 110-111  
   rear-curtain sync ..... 110-113  
   red-eye reduction ..... 110-113  
   red-eye reduction with slow sync  
     ..... 110-111, 115  
   slow sync ..... 110-111, 115  
   TTL flash control ..... 108, 112-113  
 Flash ready indicator ..... 109  
 Flexible program ..... 85  
 Focus area ..... 73-77  
 Focus lock ..... 78-79  
 Focus mode ..... 70-71, 81  
   continuous servo AF ..... 70-71  
   manual ..... 81  
   single servo AF ..... 70-71  
 Focus tracking ..... 71  
 Focusing screen ..... 194, 202  
 Folder Select ..... 140  
 Format. See Memory card  
 Frame Interval ..... 134-135
- G**  
 GPS ..... 118-119
- H**  
 High. See Image quality  
 Hide Image ..... 136-137  
 Highlights ..... 126, 142  
 Histogram ..... 126, 142
- I**  
 IEEE1394 interface. See PC mode  
 Image quality ..... 36-38, 56-61  
 Image review ..... 121  
 ISO equivalency. See Sensitivity
- J**  
 JPEG ..... 56-61
- L**  
 Language ..... 28  
 LCD illuminator ..... 105, 169  
 Lens ..... 24-25, 198-201  
   Attaching ..... 24-25  
   cleaning ..... vi  
   compatibility ..... 198-201  
   CPU Nikkor ..... 24, 198-200  
   D-Type AF Nikkor ..... 24-25, 198-200  
   G-Type AF Nikkor ..... 24-25, 198-200  
   non-CPU ..... 24, 84-90, 198-201  
   removing ..... 25  
 Long time exposure ..... 87, 90

- M**
- Manual exposure mode. See Exposure mode
  - Manual focus. See Focus mode
  - Matrix metering. See Metering
  - Memory card ..... 26-27, 143, 203
    - formatting ..... 27, 143
  - Metering ..... 41, 82-83
    - 3D color matrix ..... 83
    - and flash modes ..... 108
    - center-weighted ..... 83
    - matrix ..... 41, 83
    - spot ..... 83
  - MH-16 quick charger ..... 22, 202
  - Mirror ..... vi, 163
    - mirror up ..... 164, 196-197
  - Mode dial ..... 13, 52-53, 120-121, 149
  - Monitor pre-flash ..... 108
  - Multi-sensor balanced fill-flash for digital SLR. See Flash photography
- N**
- NEF. See Raw data
  - Nikon View 4 ..... 150-151
  - Nikon Capture 2 ..... 152-153
  - NTSC. See Video Output
  - Normal. See Image quality
- P**
- PAL. See Video Output
  - PC mode ..... 149
  - Picture angle ..... 201
  - Playback ..... 120-147
  - Playback menu ..... 17, 134-142
  - PRE. See White balance
  - Pre-flash ..... 108, 111
  - Print Set ..... 138-139
  - Programmed auto exposure mode. See Exposure mode
  - Protect ..... 132-133
- Q**
- Quick review ..... 120
- R**
- RAW data ..... 56-61, 178
  - Rear-curtain sync. See Flash photography
  - Red-eye reduction. See Flash photography
  - Red-eye reduction with slow sync. See Flash photography
  - RGB. See Image quality
  - RGB-TIFF ..... 56-61
  - RS-232C interface. See GPS

**S**

- S (Shutter-priority auto exposure mode).  
See Exposure mode
- S (Single-frame shooting). See Single-frame shooting mode
- S (Single-servo AF). See Focus mode, single-servo AF
- Self-timer ..... 13, 52, 103, 120-121
- Sensitivity ..... 38, 62-63
  - Sensitivity Boost ..... 63
- Setup menu ..... 17, 143-145, 190-191
- Shooting menu ..... 17, 188-189
- Shutter speed
  - lock ..... 94-95
  - synchronized ..... 114
- Shutter-priority auto exposure mode. See Exposure mode
- Single-frame shooting mode  
..... 13, 52, 120-121
- Single-frame playback ..... 49, 122, 124-126
- Single-servo AF. See Autofocus
- Slide Show ..... 134-135
- Slow sync. See Flash photography
- Speedlight ..... 108-115, 205-206
  - See also Flash photography
- Spot metering. See metering
- Standard TTL flash for digital SLR. See Flash photography
- Sync terminal ..... 109

**T**

- Thumbnail ..... 49, 122-123
- Time exposure. See Long time exposure
- Tone compensation ..... 175
- Two-button reset ..... 184-185

**V**

- Video Output ..... 144, 146-147
- Viewfinder diopter ..... 104

**W**

- White balance ..... 39, 64-69, 218-219

**Y**

- YCbCr. See Image quality
- YCbCr-TIFF ..... 56-61